

# DUAL PRESSURE CONTROLS

Type **DNS**

**SAGINO MIYA**

## GENERAL DESCRIPTION

- For use with fluorinated refrigerants as well as with air and water. (Allowable Fluid Temp.: -20 to 120°C)
- Various contact functions are available.
- Available drip proof enclosure for marine application or explosion proof enclosure for special application.
- Mounting bracket is supplied as standard.
- IP44 with upper lid (option).
- Ammonia models: Available upon request.

CE mark applicable (available upon request)

UL recognized (available upon request)

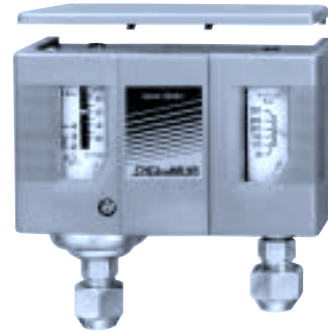

## TYPE NUMBER SELECTION (SPECIFICATIONS)

Automatic Reset Type

Unit: MPa {kgf/cm<sup>2</sup>}

Catalog No.	Pressure Side	Range		Differential		Factory Setting		Max. Working Pressure	Contact Function	Wt. (kg)
		Min.	Max.	Min.	Max.	Off	On			
<b>DNS-D304X</b>	Low Side	-0.06 {-50cmHg}	0.4 {4}	0.04 {0.4}	0.2 {2}	0.1 {1}	0.2 {2}	1.5 {15}	Diagram 1	0.49
	High Side	0.8 {8}	3 {30}	Approx. 0.4 fixed {Approx. 4 fixed}		2 {20}	1.6 {16}	3.3 {33}		
<b>DNS-D306X</b>	Low Side	-0.06 {-50cmHg}	0.6 {6}	0.06 {0.6}	0.4 {4}	0.2 {2}	0.3 {3}	1.5 {15}		
	High Side	0.8 {8}	3 {30}	Approx. 0.4 fixed {Approx. 4 fixed}		2 {20}	1.6 {16}	3.3 {33}		
<b>DNS-D604X</b>	Low Side	-0.06 {-50cmHg}	0.4 {4}	0.04 {0.4}	0.2 {2}	0.1 {1}	0.2 {2}	1.5 {15}	Diagram 3	
	High Side	0.8 {8}	3 {30}	Approx. 0.4 fixed {Approx. 4 fixed}		2 {20}	1.6 {16}	3.3 {33}		
<b>DNS-D606X</b>	Low Side	-0.06 {-50cmHg}	0.6 {6}	0.06 {0.6}	0.4 {4}	0.2 {2}	0.3 {3}	1.5 {15}		
	High Side	0.8 {8}	3 {30}	Approx. 0.4 fixed {Approx. 4 fixed}		2 {20}	1.6 {16}	3.3 {33}		

Manual Reset Type

Unit: MPa {kgf/cm<sup>2</sup>}

Catalog No.	Pressure Side	Range		Differential		Factory Setting		Max. Working Pressure	Contact Function	Wt. (kg)
		Min.	Max.	Min.	Max.	Off	On			
<b>DNS-D304XM</b>	Low Side	-0.06 {-50cmHg}	0.4 {4}	0.04 {0.4}	0.2 {2}	0.1 {1}	0.2 {2}	1.5 {15}	Diagram 2	0.49
	High Side	0.8 {8}	3 {30}	Automatic operation on pressure rise, and manual reset.		2 {20}	manual reset	3.3 {33}		
<b>DNS-D306XM</b>	Low Side	-0.06 {-50cmHg}	0.6 {6}	0.06 {0.6}	0.4 {4}	0.2 {2}	0.3 {3}	1.5 {15}		
	High Side	0.8 {8}	3 {30}	Automatic operation on pressure rise, and manual reset.		2 {20}	manual reset	3.3 {33}		
<b>DNS-D604XM</b>	Low Side	-0.06 {-50cmHg}	0.4 {4}	0.04 {0.4}	0.2 {2}	0.1 {1}	0.2 {2}	1.5 {15}	Diagram 4	
	High Side	0.8 {8}	3 {30}	Automatic operation on pressure rise, and manual reset.		2 {20}	manual reset	3.3 {33}		
<b>DNS-D606XM</b>	Low Side	-0.06 {-50cmHg}	0.6 {6}	0.06 {0.6}	0.4 {4}	0.2 {2}	0.3 {3}	1.5 {15}		
	High Side	0.8 {8}	3 {30}	Automatic operation on pressure rise, and manual reset.		2 {20}	manual reset	3.3 {33}		
<b>DNS-D606XMM</b>	Low Side	-0.06 {-50cmHg}	0.6 {6}	Automatic operation on pressure decrease, and manual reset.		0.2 {2}	manual reset	1.5 {15}	Diagram 5	
	High Side	0.8 {8}	3 {30}	Automatic operation on pressure rise, and manual reset.		2 {20}	manual reset	3.3 {33}		

• Enclosure: IP20

• Drip Proof Models: Available upon request. (Refer to Pages 48, 49.)

## ELECTRICAL RATINGS

Rated Voltage (V)		Power Factor (cos $\phi$ )	125/250V. AC
Rated Amps. (A)			
Non-Inductive Current		1	12
Inductive Current	Full Load	0.75	
	Locked Rotor	0.45	72

## CONTACT FUNCTIONS

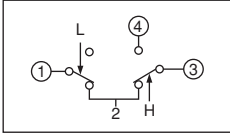

Diagram 1

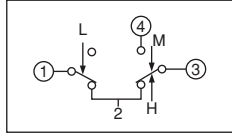

Diagram 2

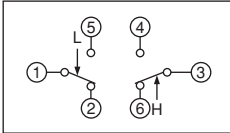

Diagram 3

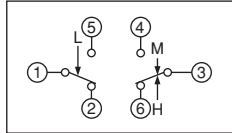

Diagram 4

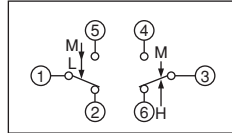
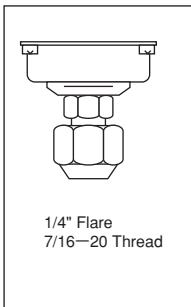

Diagram 5

↓ L: Operating direction on press. increase at Low Press. Side  
 ↑ H: Operating direction on press. increase at High Press. Side  
 ↓ M: Operating direction on manual reset

## PRESSURE CONNECTIONS



Standard

Refer to Pages 45, 46

## DIMENSIONS

Standard Model

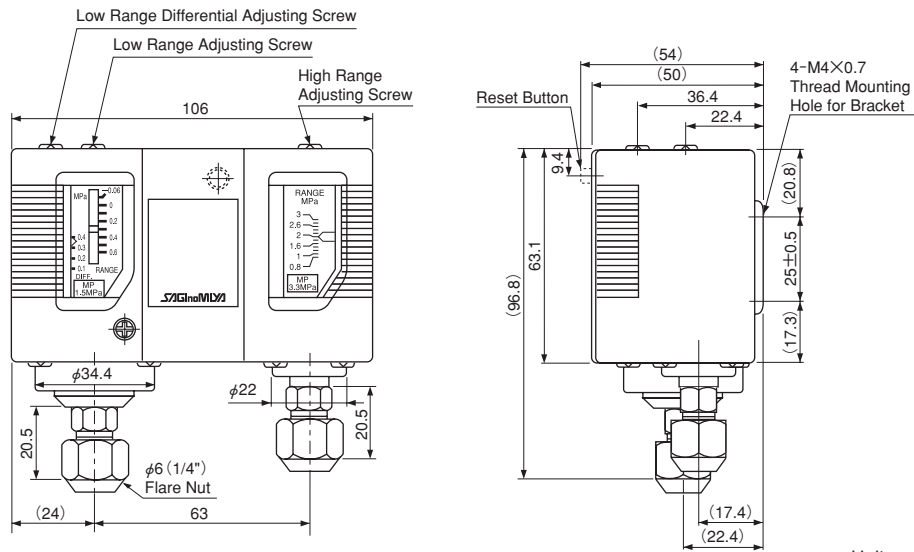

Unit: mm