

9. OUTLINE OF OPERATION CONTROL BY MICROCOMPUTER

(1) Operation control function by wireless remote control

Operation section

OPERATION MODE select button

Each time the button is pressed, the mode changes.

TEMPERATURE button

This button sets the room temperature.

HI/ECO button

This button changes the HIGH POWER/ECONOMY operation.

AIR FLOW (LEFT/RIGHT) button

This button changes the air flow (left/right) direction.

SILENT button

This button sets the SILENT operation.

ALLERGEN CLEAR button

This button selects ALLERGEN CLEAR operation.

ON TIMER button

This button selects ON TIMER operation.

OFF TIMER button

This button selects OFF TIMER operation.

WEEKLY button

This button switches the WEEKLY TIMER to ON/OFF.

MENU switch

This switch selects the CLEAN operation, display brightness adjustment, Fan control in heating thermo off, wireless LAN communication setting, wireless LAN connection setting and PRESET operation.

SLEEP button

This button selects SLEEP operation.

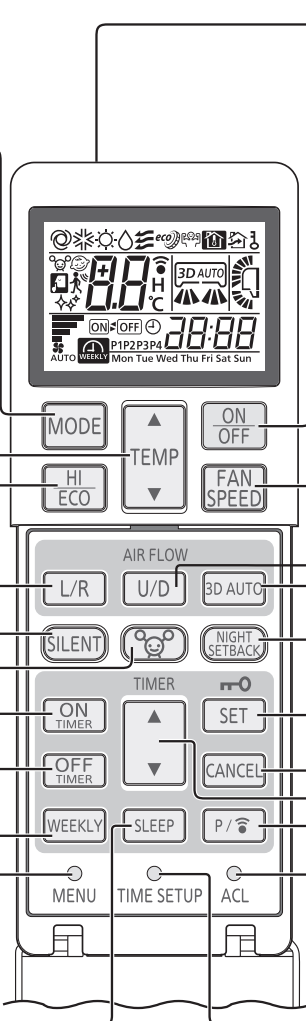

[View with the cover opened]

The above illustration shows all controls, but in practice only the relevant parts are shown.

Transmission section

ON/OFF (luminous) button

Press to start operation, press again to stop.

FAN SPEED button

Each time the button is pressed, the fan speed changes.

AIR FLOW (UP/DOWN) button

This button changes the air flow (up/down) direction.

3D AUTO button

This button sets 3D AUTO operation.

NIGHT SETBACK button

This button sets NIGHT SETBACK operation.

SET/Child lock button

Use this button to set the timer and Child lock.

CANCEL button

This button cancels the ON timer, OFF timer, and SLEEP operation.

TIMER button

This button is used for setting the current time and timer function.

PROGRAM button

This button sets WEEKLY TIMER.

ACL switch

This switch resets the program to default state.

TIME SET UP switch

This switch is used for setting the time.

Unit display section

RUN light (green)

- Illuminates during operation.
- Blinks slowly when CLEAN operation (3 seconds ON, 1 second OFF).
- Blinks when air flow is stopped to prevent blowing out of cold air in heating operation. (1.5 seconds ON, 0.5 seconds OFF)

Wireless remote control signal receiver

Unit ON/OFF button

This button can be used for turning on/off the unit when a remote control is not available.

TIMER light (yellow)

Illuminates during TIMER operation.

• RUN and TIMER lights blink quickly during invalid operation mode.

(2) Unit ON/OFF button

When the wireless remote control batteries become weak, or if the wireless remote control is lost or malfunctioning, this button may be used to turn the unit on and off.

(a) Operation

Push the button once to place the unit in the automatic mode. Push it once more to turn the unit off.

(b) Details of operation

The unit will go into the automatic mode in which it automatically determines, from room temperature (as detected by sensor), whether to go into the COOL or HEAT modes.

Function Operation mode	Room temperature setting	Fan speed	Flap/Louver	Timer switch
COOL	About 24°C	Auto	Auto	Continuous
HEAT	About 26°C			

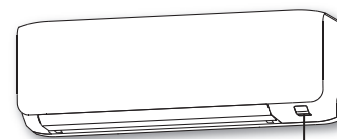

Unit ON/OFF button

(3) Auto restart function

- (a) Auto restart function records the operational status of the air-conditioner immediately prior to be switched off by a power cut, and then automatically resumes operations after the power has been restored.
- (b) The following settings will be cancelled:
 - (i) Timer settings
 - (ii) HIGH POWER operation

- Notes
- (1) Auto restart function is set at on when the air-conditioner is shipped from the factory. Consult with your dealer if this function needs to be switched off.
 - (2) When power failure occurs, the timer setting is cancelled. Once power is resumed, reset the timer.
 - (3) If the jumper wire (J1) "AUTO RESTART" is cut, auto restart is disabled. (See the diagram at right.)

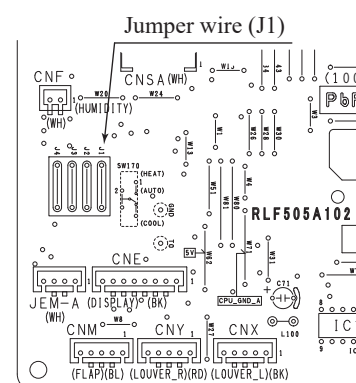

(4) Installing two air-conditioners in the same room

In case two air-conditioners are installed in the same room, apply this setting so that one unit can be operated with only one remote control.

(a) Setting the wireless remote control

- (i) Slide the cover and take out the batteries.
- (ii) Disconnect the switching line next to the battery with wire cutters.
- (iii) Set the batteries and cover again.

(b) Setting an indoor unit

- (i) Turn off the power source, and turn it on after 1 minute.
- (ii) Point the wireless remote control (that was set according to the procedure described on the left side) at the indoor unit and send a signal by pressing the ACL switch on the wireless remote control.

Since the signal is sent in about 6 seconds after the ACL switch is pressed, point the wireless remote control at the indoor unit for some time.
- (iii) Check that the reception buzzer sound "Peep" is emitted from the indoor unit.

At completion of the setting, the indoor unit emits a buzzer sound "Peep".
(If no reception sound is emitted, start the setting from the beginning again.)

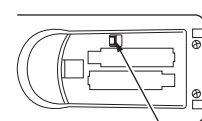

Disconnect

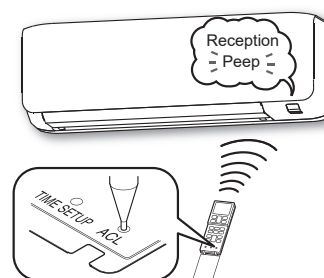

(5) Selection of the annual cooling function

- (a) The annual cooling control is valid from factory default setting. It is possible to disable by cutting jumper wire (J3), or changing the setting of dip switch (SW2-4) on the interface kit (option) PCB if it is connected.

Jumper wire (J3)	Interface kit (SC-BIKN2-E) SW2-4	Function
Shorted	ON	Enabled
Shorted	OFF	Disabled
Open	ON	Disabled
Open	OFF	Disabled

Note: (1) Default states of the jumper wire (J3) and the interface kit at the shipping from factory – On the PCB, the dip switch (SW2-4) is set to enable the annual cooling function.

(2) To cancel the annual cooling setting, consult your dealer.

(b) Content of control

- (i) If the outdoor air temperature sensor (TH3 (SRK50 : TH2)) detects below 5°C, the indoor unit speed is switched to 7th step.
- (ii) If the outdoor air temperature sensor (TH3 (SRK50 : TH2)) detects higher than 10°C, the indoor unit speed is changed to the normal control speed.

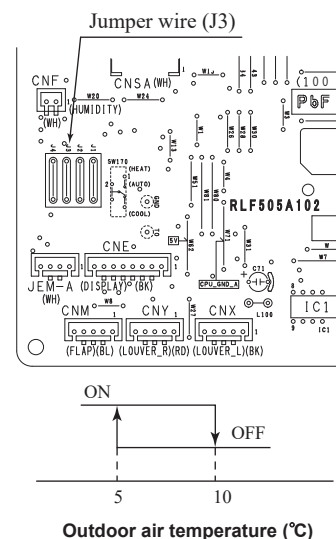

(6) Heating only function

- (a) Heating of unit is enabled when cutting jumper wire (J4).

(b) Content of control

Operation setting	Operation
COOL/DRY/FAN	FAN
AUTO/HEAT	HEAT

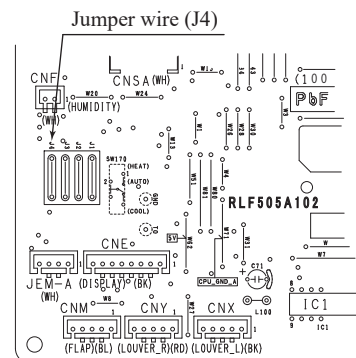

(7) High power operation

Pressing the HI POWER/ECONOMY button notifies the performance level and indicates powerful cooling and heating ratio for 15 minutes continuously. The wireless remote control display HIGH POWER mark and the FAN SPEED display appears.

- (a) During the HIGH POWER operation, the room temperature is not controlled. When it causes an excessive cooling and heating, press the HI POWER/ECONOMY button again to cancel the HIGH POWER performance.
- (b) HIGH POWER performance starts immediately after the DRY and the ON timer to OFF timer performance.
- (c) When the HIGH POWER performance is set after ON timer performance, HIGH POWER performance will start from the set time.
- (d) When the follow-up performance is set, HIGH POWER performance will be cancelled.
 - When the HI POWER/ECONOMY button is pressed again
 - When the performance is changed
 - When the 5-minute interval sine HIGH POWER performance is started
 - When the 3D AUTO button is pressed
 - When the SILENT button is pressed
 - When the NIGHT SETBACK button is pressed
- (e) No performance when the air-conditioner is OFF.
- (f) After HIGH POWER performance is sound, refrigerant flow is automatically adjusted.

(8) Economy operation

Pressing the HI POWER/ECONOMY button initiates a soft operation with the power suppressed in order to avoid an excessive cooling or heating. The unit operate 1.5°C higher than the setting temperature during cooling or 2.5°C lower than that during heating. The wireless remote control displays ECONOMY mark and the FAN SPEED display disappears.

- (a) It will go into ECONOMY operation at the next time the air-conditioner runs in the following cases.
 - ① When the air-conditioner is stopped by ON/OFF button during ECONOMY operation.
 - ② When the air-conditioner is stopped in SLEEP or OFF TIMER operation during ECONOMY operation.
 - ③ When the operation is retrieved from CLEAN or ALLERGEN CLEAR operation.
- (b) When the following operation are set, ECONOMY operation will be cancelled.
 - ① When the HI POWER/ECONOMY button is pressed again.
 - ② When the operation mode is changed from DRY to FAN.
 - ③ When the NIGHT SETBACK button is pressed.
- (c) Not operable while the air-conditioner is OFF.
- (d) The setting temperature is adjusted according to the following table.

Item \ Mode	Cooling	Heating	
Temperature adjustment	① +0.5	① -1.0	① at the start of operation.
	② +1.0	② -2.0	② one hour after the start of operation.
	③ +1.5	③ -2.5	③ two hours after the start of operation.

(9) Air flow direction adjustment



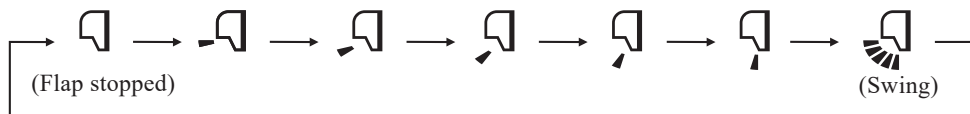

Air flow direction can be adjusted with by AIR FLOW  (UP/DOWN) and  (LEFT/RIGHT) button on the wireless remote control.

(a) Flap

Every time when you press the AIR FLOW  (UP/DOWN) button the mode changes as follows.



• Angle of flap from horizontal



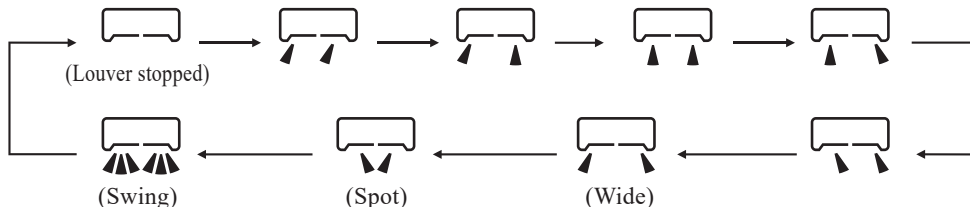

Wireless remote control display					
COOL, DRY, FAN	Approx. 25°	Approx. 30°	Approx. 40°	Approx. 50°	Approx. 60°
HEAT	Approx. 25°	Approx. 35°	Approx. 50°	Approx. 60°	Approx. 70°

(b) Louver

Every time when you press the AIR FLOW  (LEFT/RIGHT) button the mode changes as follows.



• Angle of louver

Wireless remote control display					
Center installation	Left approx. 50°	Left approx. 20°	Center	Right approx. 20°	Right approx. 50°
Right end installation	Left approx. 50°	Left approx. 45°	Left approx. 30°	Center	Right approx. 20°
Left end installation	Left approx. 20°	Center	Right approx. 30°	Right approx. 45°	Right approx. 50°

(c) Swing**(i) Swing flap**

Flap moves in upward and downward directions continuously.

◆ In COOL, DRY, FAN operation

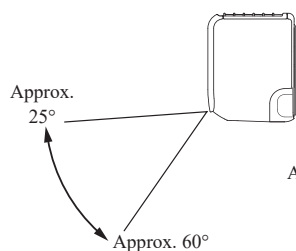

◆ In HEAT operation

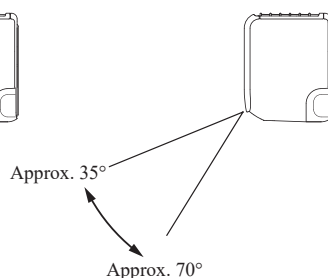
**(ii) Swing louver**

Louver moves in left and right directions continuously.

**(d) Memory flap (Flap or louver stopped)**

When you press the AIR FLOW (UP/DOWN or LEFT/RIGHT) button once while the flap or louver is operating, it stops swinging at the position. Since this angle is memorized in the microcomputer, the flap or louver will automatically be set at this angle when the next operation is started.

(10) 3D auto operation

Control the flap and louver by 3D AUTO button on the wireless remote control.

Fan speed and air flow direction are automatically controlled, allowing the entire indoor to efficiently conditioned.

(a) During cooling and heating (Including auto cooling and heating)**(i) Air flow selection is determined according to indoor temperature and setting temperature.**

Operation mode	Air flow selection				
	AUTO		HI	MED	LO
Cooling	Room temp. – Setting temp. >5°C	Room temp. – Setting temp. ≤5°C	HI	MED	LO
	HIGH POWER	AUTO			
Heating	Setting temp. – Room temp. >5°C	Setting temp. – Room temp. ≤5°C	HI	MED	LO
	HIGH POWER	AUTO			

(ii) Air flow direction is controlled according to the room temperature and setting temperature.**1) When 3D auto operation starts**

	Cooling	Heating
Flap	Up/down swing	
Louver	Wide (Fixed)	Center (Fixed)

2) When Room temp. – Setting temp. is ≤5°C during cooling and when setting temp. – Room temp. is ≤5°C during heating, the system switches to the following air flow direction control. After the louver swings left and right symmetrically for 3 cycles, control is switched to the control in 3).

	Cooling	Heating
Flap	Horizontal blowing (Fixed)	Slant forward blowing (Fixed)
Louver	Left/right swing	

3) After the flap swings for 5 cycles, control is switched to the control in 4).

	Cooling	Heating
Flap	Up/down swing	
Louver	Center (Fixed)	

- 4) For 5 minutes, the following air flow direction control is carried out.

	Cooling	Heating
Flap	Horizontal blowing (Fixed)	Slant forwardl blowing (Fixed)
Louver	Wide (Fixed)	

- 5) After 5 minutes have passed, the air flow direction is determined according to the room temperature and setting temperature.

Operation mode	Air flow direction control		
Cooling	Room temp. – Setting temp. $\leq 2^{\circ}\text{C}$	$2^{\circ}\text{C} < \text{Room temp.} - \text{Setting temp.} \leq 5^{\circ}\text{C}$	Room temp. – Setting temp. $> 5^{\circ}\text{C}$
	The control in 4) continues.	Control returns to the control in 2).	Control returns to the control in 1).
Heating	Setting temp. – Room temp. $\leq 2^{\circ}\text{C}$	$2^{\circ}\text{C} < \text{Setting temp.} - \text{Room temp.} \leq 5^{\circ}\text{C}$	Setting temp. – Room temp. $> 5^{\circ}\text{C}$
	The control in 4) continues.	Control returns to the control in 2).	Control returns to the control in 1).

- (b) During DRY operation

Flap	Horizontal blowing (Fixed)
Louver	Wide (Fixed)

(11) Timer operation

(a) Comfort start-up (ON timer operation)

The unit starts the operation 5 to 60 minutes earlier so that the room can approach optimum temperature at ON timer.

(b) Sleep timer operation

Pressing the SLEEP button causes the temperature to be controlled with respect to the set temperature.

(c) OFF timer operation

The OFF timer can be set at a specific time (in 10-minute units) within a 24-hour period.

(d) Weekly timer operation

Up to 4 programs with timer operation (ON timer / OFF timer) are available for each day of the week.

Note Timer operation from wireless remote control becomes in invalid when you connect the interface kit (such as SC-BIKN2-E).

(e) Combination of patterns which can be set for the timer operations

Item	Sleep timer	OFF timer	ON timer	Weekly timer
Sleep timer		×	○	×
OFF timer	×		○	×
ON timer	○	○		×
Weekly timer	×	×	×	

Notes (1) ○: Allowed ×: Not

- (2) Since the ON timer, sleep timer and OFF timer are set in parallel, when the times to turn ON and OFF the air-conditioner are duplicated, the setting of the OFF timer has priority.

(12) Silent operation

When the silent operation is set, the unit operates by dropping the outdoor fan speed and the compressor speed.

	SRK20		SRK25		SRK35		SRK50	
	Cooling	Heating	Cooling	Heating	Cooling	Heating	Cooling	Heating
Outdoor fan speed (Upper limit)	4th speed	4th speed	4th speed	4th speed	5th speed	4th speed	4th speed	4th speed
Compressor speed (Upper limit)	30 rps	46 rps	37 rps	49 rps	46 rps	56 rps	46 rps	70rps

(13) Night setback operation

When the night setback operation is set, the heating operation starts with the setting temperature at 10°C.

(14) Air flow range setting

Take the air-conditioner location into account and adjust the left/right air flow range to maximize air-conditioning.

(a) Setting

- (i) If the air-conditioning unit is running, press the ON/OFF button to stop.
The installation location setting cannot be made while the unit is running.

- (ii) Press the AIR FLOW U/D (UP/DOWN) button and the AIR FLOW L/R (LEFT/RIGHT) button together for 5 seconds or more.

The installation location display illuminates.

- (iii) Setting the air-conditioning installation location.

Press the AIR FLOW L/R (LEFT/RIGHT) button and adjust to the desired location.

Each time the AIR FLOW L/R (LEFT/RIGHT) button is pressed, the indicator is switched in the order of:

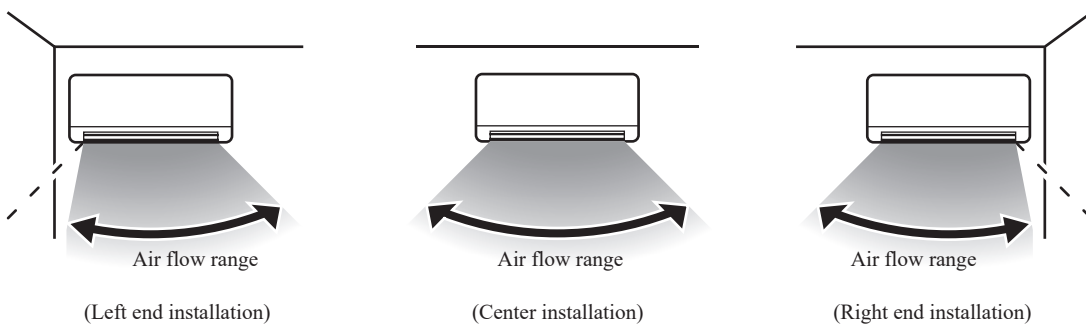
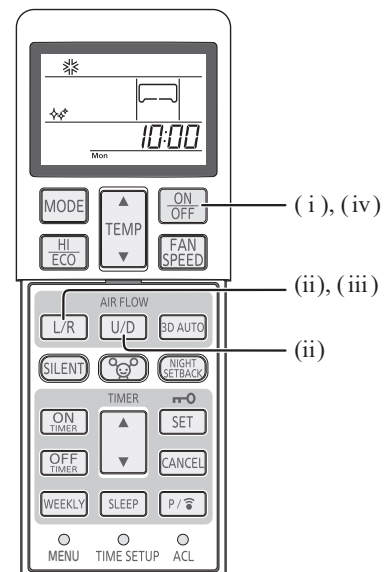

- (iv) Press the ON/OFF button.

The air-conditioner's installation location is set.

Press within 60 seconds of setting the installation location (while the installation location setting display illuminates).

(15) Display brightness adjustment

This function can be used when it is necessary to adjust the brightness of unit display.

Brightness level	Run light	Timer light
LV2	10%	10%
LV1	5%	5%
LV0	0%	0%

Note(1) When the unit displays self diagnosis or service mode, brightness level is always LV2.

(16) Wireless LAN connection function**(a) Operating conditions**

When a signal of wireless LAN connection setting was received from a remote control during all air-conditioners stop

(b) Detail of operation

- (i) A signal which corresponds to the signal received from a remote control is sent to interface.
- (ii) A buzzer for confirmation of receipt rings.

(c) Reset conditions

When either of the following conditions is satisfied

- (i) When a reception complete signal was received from interface
- (ii) When an interface communication setting OFF signal was received from a remote control

Note: Regarding a long buzzer sound (In wireless LAN connection setting)

When RUN light and TIMER light blink simultaneously (at an interval of 2 seconds) and you push the remote control button, the indoor unit may emit a long buzzer sound for approximately 3 seconds.

The occurrence of this buzzer sound is not abnormal.

(17) Fan control during heating thermostat OFF

- (i) Following fan controls during the heating thermostat OFF can be selected with the wireless remote control.
 - 1) Normal thermostat operation 2) Fireplace 3) Interval 4) Stop
- (ii) When the "Normal thermostat operation" is selected, the indoor fan is controlled by HOT KEEP.
- (iii) When the "Fireplace" is selected, it is operated with the set fan speed also in the thermostat OFF condition.
- (iv) If the "Interval" is selected, following controls are performed:
 - 1) If the thermostat is turned OFF during the heating operation, the indoor unit turns OFF the indoor fan.
 - 2) Indoor fan OFF is fixed for 5 minutes. After the 5 minutes, the indoor fan is operated at ① tap for 1 minute.
 - 3) After operating at ① tap for 1 minute, the indoor fan moves to the state of 1) above.
- (v) When the "Stop" is selected, the fan on the indoor unit of which the thermostat has been turned OFF, is turned OFF.

Note To use "Stop" function, additional work in which the suction temperature sensor can detect the room temperature appropriately is required. Otherwise, it may take time to return to heating and the heating capacity may be insufficient.

(18) Outline of heating operation

(a) Operation of major functional components in heating mode

	Heating		
	Thermostat ON	Thermostat OFF	Failure
Compressor	ON	OFF	OFF
Indoor fan motor	ON	ON(HOT KEEP)*	OFF
Outdoor fan motor	ON	OFF (few minutes ON)	OFF
4-way valve	ON	ON	OFF (3 minutes ON)

*When a wired remote control is connected, a signal of a wired remote control is priority. HOT KEEP, Fireplace, Interval and Stop can be established.
In the case, indoor air temperature is detected by sensor on the wired remote control.

(b) Details of control at each operation mode (pattern)

(i) Fuzzy operation

Deviation between the indoor temperature setting correction temperature and the return air temperature is calculated in accordance with the fuzzy rule, and used for control of the air capacity and the compressor speed.

Model	SRK20	SRK25	SRK35	SRK50
Fan speed				
Auto	20-115rps	20-115rps	20-115rps	20-110rps
HI	20-115rps	20-115rps	20-115rps	20-110rps
MED	20-86rps	20-104rps	20-108rps	20-106rps
LO	20-70rps	20-84rps	20-96rps	20-94rps
ULO	20-44rps	20-54rps	20-60rps	20-63rps

When the defrost operation, protection device, etc. is actuated, operation is performed in the corresponding mode.

(ii) Hot keep operation

During the heating operation, the indoor fan speed can be controlled based on the temperature of the indoor heat exchanger (Th2) to prevent blowing out of cold air.

(c) Defrost operation

(i) Starting conditions (Defrost operation can be started only when all of the following conditions are satisfied.)

- 1) After start heating operation
When it elapsed 35 minutes. (Total compressor operation time)
- 2) After finish of defrost operation
When it elapsed 35 minutes. (Total compressor operation time)
- 3) Outdoor heat exchanger sensor (TH2 (SRK50 : TH1)) temperature
When the temperature has been -5°C or less for 3 minutes continuously.
- 4) The difference between the outdoor air sensor temperature and the outdoor heat exchanger sensor temperature is as following.

Models SRK20, 25

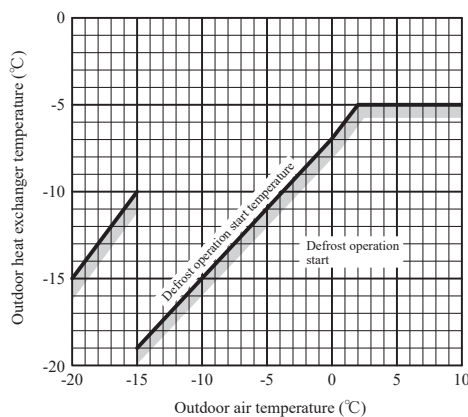

Models SRK35, 50

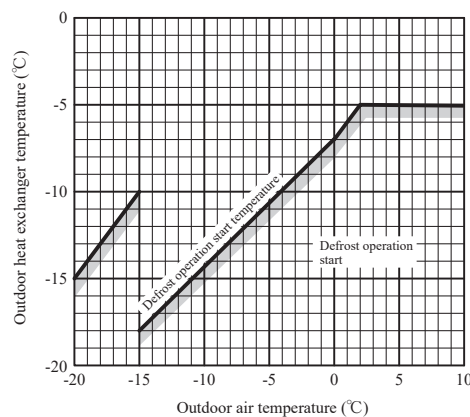

- 5) During continuous compressor operation
In case satisfied all of following conditions.
- Connect compressor speed 0 rps 10 times or more.
 - Satisfy 1), 2) and 3) conditions above.
 - Outdoor air temperature is 3°C or less.
- (ii) Ending conditions (Operation returns to the heating cycle when either one of the following is satisfied.)
- 1) Outdoor heat exchanger sensor (TH2 (SRK50 : TH1)) temperature: 13°C (model SRK50 : 10°C) or higher
 - 2) Continued operation time of defrost operation → For more than 15 minutes

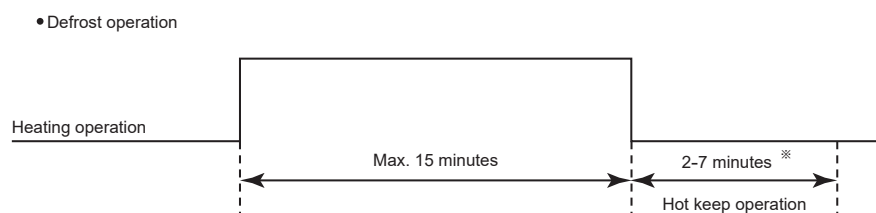

※Depends on an operation condition, the time can be longer than 7 minutes.

(d) Countermeasure for excessive temperature rise

If it feels excessive temperature rise in heating operation, setting temperature can be lower.

(i) Setting

Push ON/OFF button 30 seconds or more after turn on the power source and operate the air-conditioner at least once time, At completion of the setting, the indoor unit emits a buzzer sound “Pip”.

(ii) Contents of control

Unit : °C

	Signal of wireless remote control (Display)												
	18	19	20	21	22	23	24	25	26	27	28	29	30
Before setting	20	21	22	23	24	25	26	27	28	29	30	31	32
After setting	18	19	20	21	22	23	24	25	26	27	28	29	30

(iii) Reset condition

Push ON/OFF button 30 seconds or more during setting this mode. At completion of the reset, the indoor unit emits a buzzer sound “PiPiPi”.

(19) Outline of cooling operation

(a) Operation of major functional components in cooling mode

	Cooling		
	Thermostat ON	Thermostat OFF	Failure
Compressor	ON	OFF	OFF
Indoor fan motor	ON	ON	OFF
Outdoor fan motor	ON	OFF (few minutes ON)	OFF (few minutes ON)
4-way valve	OFF	OFF	OFF

(b) Detail of control in each mode (Pattern)

(i) Fuzzy operation

During the fuzzy operation, the air flow and the compressor speed are controlled by calculating the difference between the indoor temperature setting correction temperature and the return air temperature.

Fan speed	Model	SRK20	SRK25	SRK35	SRK50
	Auto		15-66rps	15-74rps	15-98rps
HI		15-66rps	15-74rps	15-98rps	20-100rps
MED		15-52rps	15-60rps	15-80rps	20-82rps
LO		15-42rps	15-48rps	15-70rps	20-66rps
ULO		15-34rps	15-38rps	15-46rps	20-40rps

(20) Outline of dehumidifying (DRY) operation

(a) Purpose of DRY mode

The purpose is "Dehumidification", and not to control the humidity to the target condition. Indoor/outdoor unit control the operation condition to reduce the humidity, and also prevent over cooling.

(b) Outline of control

(i) Indoor unit fan speed and compressor are controlled by the area which is selected by the temperature difference.

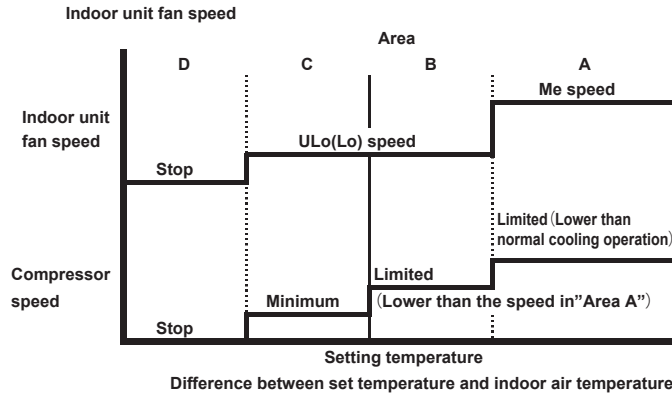

(ii) The indoor unit checks the current area by every 5 minutes, and operates by the next checking.

(c) Other

When the outdoor air temperature and room temperature are low in cooling operation, indoor unit can not operate cooling mode, and DRY mode. In this case, the unit operates in heating mode to rise the indoor air temperature and after that start DRY mode.

(21) Outline of automatic operation

(a) Determination of operation mode

Operation mode is determined by indoor air temperature and outdoor air temperature as following.

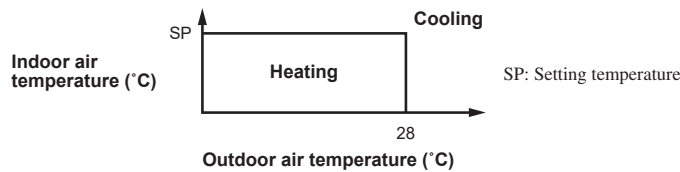

(b) Operation mode is changes when keep cooling and heating thermostat off 20 minutes and be satisfied with following conditions. If the setting temperature is changed with the remote control, the operation mode is judged immediately.

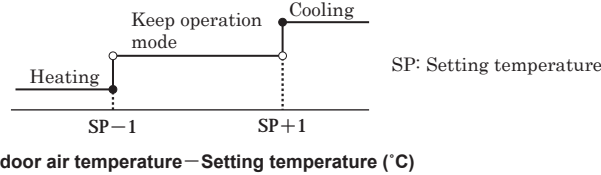

※It can not be changed to heating mode if outdoor air temperature is 28°C or higher.

(c) When the unit is started again within one hour after the stop of automatic operation or when the automatic operation is selected during heating, cooling or DRY mode, the unit is operated in the previous operation mode.

(d) Setting temperature can be adjusted within the following range. There is the relationship as shown below between the signals of the wireless remote control and the setting temperature.

		Signals of wireless remote control display													
		18	19	20	21	22	23	24	25	26	27	28	29	30	
Setting temperature	Cooling														
	Heating	20	21	22	23	24	25	26	27	28	29	30	31	32	

(e) When the unit is operated automatically with the wired remote control, the cooling operation is controlled according to the display temperatures while the setting temperature is compensated by +2°C during heating.

(22) Protective control function

(a) Dew prevention control (During cooling)

Prevents dewing on the indoor unit.

(i) Operating conditions

When the following conditions have been satisfied for more than 30 minutes after starting operation

- 1) Compressor's speed is 32 (model SRK50:28) rps or higher.
- 2) Detected value of humidity is 68% or higher.

(ii) Contents of operation

- 1) Air capacity control

Item		Model	SRK20, 25, 35	SRK50
LO,ULO	Upper limit of compressor's speed		RangeA: 60rps, RangeB: 60rps	RangeA: 62rps, RangeB: 50rps
	Indoor fan		4th speed (SRK35 : 5th speed)	4th speed
AUTO,HI,MED	Upper limit of compressor's speed		RangeA: 60rps, RangeB: 60rps	RangeA: 62rps, RangeB: 50rps
	Indoor fan		Adaptable to compressor speed	
			(SRK20, 25 : Lower limit 4th speed) (SRK35 : Lower limit 5th speed)	(Lower limit 4th speed)

Note (1) Ranges A and B are as shown below.

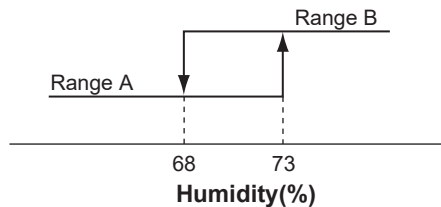

- 2) When this control has continued for more than 30 minutes continuously, the following wind direction control is performed.
 - a) When the vertical wind direction is set at other than the vertical swing, the flaps change to the horizontal position.
 - b) When the horizontal wind direction is set at other than the horizontal swing, the louver changes to the vertical position.

(iii) Reset condition

Humidity is less than 63%.

(b) Frost prevention control (During cooling or dehumidifying)

(i) Operating conditions

- 1) Indoor heat exchanger temperature (Th2) is lower than 5°C.
- 2) 5 minutes after reaching the compressor speed except 0 rps.

(ii) Detail of anti-frost operation

Item	Indoor heat exchanger temperature	
	5°C or lower	2.5°C or lower
Lower limit of compressor command speed	22 rps(model SRK50 : 23 rps)	0 rps
Indoor fan	Depends on operation mode	Keep the fan speed before frost prevention control
Outdoor fan	Depends on compressor speed	Depends on stop mode
4-way valve	OFF	

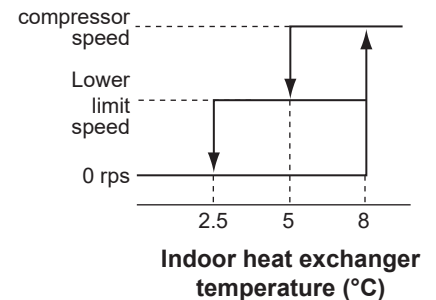

- Notes
- (1) When the indoor heat exchanger temperature is in the range of 2.5–5°C, the speed is reduced by 4 rps at each 20 seconds.
 - (2) When the temperature is lower than 2.5°C, the compressor is stopped.
 - (3) When the indoor heat exchanger temperature is in the range of 5–8°C, the compressor speed is been maintained.

(iii) Reset conditions

When either of the following condition is satisfied

- 1) The indoor heat exchanger temperature (Th2) is 8°C or higher.
- 2) The compressor speed is 0 rps.

(c) Cooling overload protective control

(i) Operating conditions

When the outdoor air temperature (TH3 (SRK50 : TH2)) has become continuously for 30 seconds at 41°C or more, or 47°C or more with the compressor running, the lower limit speed of compressor is brought up.

Item	SRK20-35		SRK50	
	41°C or more	47°C or more	41°C or more	47°C or more
Outdoor air temperature	41°C or more	47°C or more	41°C or more	47°C or more
Lower limit speed	30 rps	45 rps	27 rps	35 rps

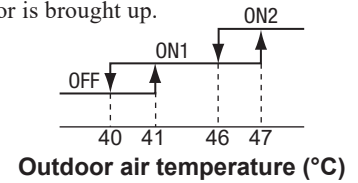

(ii) Detail of operation

- 1) The outdoor fan is stepped up by 3 speed step. [Upper limit 8th speed.]
- 2) The lower limit of compressor speed is set to 30 or 45 (model SRK50 : 27 or 35) rps.

However, when the thermo OFF, the speed is reduced to 0 rps.

(iii) Reset conditions

When either of the following condition is satisfied

- 1) The outdoor air temperature is lower than 40°C.
- 2) The compressor speed is 0 rps.

(d) Cooling high pressure control

(i) Purpose

Prevents anomalous high pressure operation during cooling.

(ii) Detector

Outdoor heat exchanger sensor (TH2 (SRK50 : TH1)).

(iii) Detail of operation

(Example) Compressor speed

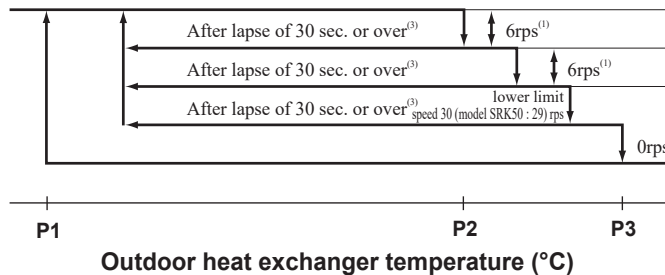

	TH2 (SRK50 : TH1)(°C)			
	P1	P2	P3	
SRK20, 25	Range A	47	50	53
	Range B	53	58	63
SRK35, 50	Range A	48	53	55
	Range B	53	58	63

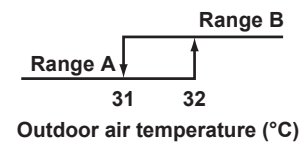

- Notes
- (1) When the outdoor heat exchanger temperature is in the range of P2-P3°C, the speed is reduced by 6 rps at each 30 seconds.
 - (2) When the temperature is P3°C or higher, the compressor is stopped.
 - (3) When the outdoor heat exchanger temperature is in the range of P1-P2°C, if the compressor speed is been maintained and the operation has continued for more than 30 seconds at the same speed, it returns to the normal cooling operation.

(e) Cooling low outdoor air temperature protective control

(i) Operating conditions

When the outdoor air temperature (TH3 (SRK50 : TH2)) is 22°C or lower continues for 20 seconds while the compressor speed is other than 0 rps.

(ii) Detail of operation

- 1) It controls the upper and lower limit values for the compressor speed according to the following table.
- 2) It checks the outdoor air temperature (TH3 (SRK50 : TH2)) once every hour to judge the operation range.

	Compressor speed: Upper/lower limit (rps)						
	Lower 1		Upper 1	Lower 2	Upper 2	Lower 3	Upper 3
	Range B	Range A					
SRK20, 25, 35	30	Release	60	44	50	50	50
SRK50	27	Release	60	44	50	—	—

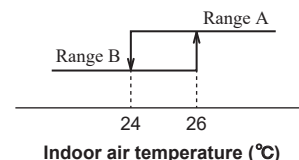

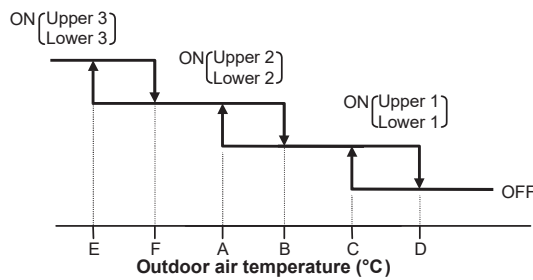

● Values of A, B, C, D, E, F (Models SRK20-35)

	Outdoor air temperature (°C)					
	E	F	A	B	C	D
First time	-8	-5	0	3	22	25
After the second times	-2	1	5	8	25	28

● Values of A, B, C, D (Model SRK50)

	Outdoor air temperature (°C)			
	A	B	C	D
First time	9	11	22	25
After the second times	16	19	25	28

(iii) **Reset conditions**

When either of the following condition is satisfied

- 1) The outdoor air temperature (TH3 (SRK50 : TH2)) is D°C or higher.
- 2) The compressor speed is 0 rps.

(f) **Heating high pressure control**

(i) **Purpose**

Prevents anomalous high pressure operation during heating.

(ii) **Detector**

Indoor heat exchanger sensor (Th2)

(iii) **Detail of operation**

(Example)

Compressor speed

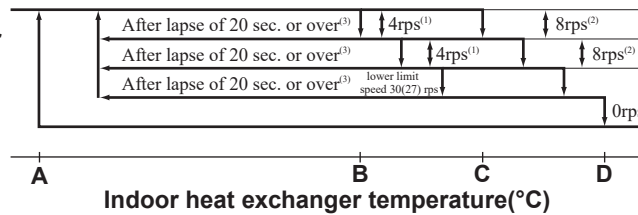

Note (1) Value in () are for the model SRK50.

- Notes
- (1) When the indoor heat exchanger temperature is in the range of B-C °C, the speed is reduced by 4 rps at each 20 seconds.
 - (2) When the indoor heat exchanger temperature is in the range of C-D °C, the speed is reduced by 8 rps at each 20 seconds. When the temperature is D °C or higher continues for 1 minute, the compressor is stopped.
 - (3) When the indoor heat exchanger temperature is in the range of A-B °C, if the compressor speed is been maintained and the operation has continued for more than 20 seconds at the same speed, it returns to the normal heating operation.
 - (4) Indoor fan retains the fan speed when it enters in the high pressure control. Outdoor fan is operated in accordance with the speed.

● **Temperature list**
Models SRK20, 25, 35

Unit : °C

	A	B	C	D
RPSmin < 50	47	52	54	58
50 ≤ RPSmin < 92	47.5	55	57	61
92 ≤ RPSmin ≤ 115	47.5 - 39	55 - 40	57 - 42	61

Note (1) RPSmin: The lower one between the outdoor speed and the compressor speed

Model SRK50

Unit : °C

	A	B	C	D
RPSmin < 35	49	54	55	55.5
35 ≤ RPSmin < 40	49 - 52	54 - 57	55 - 58	55.5 - 62
40 ≤ RPSmin < 80	52	57	58	62
80 ≤ RPSmin < 95	52 - 48.1	57 - 52.2	58 - 53.2	62 - 56
95 ≤ RPSmin < 115	48.1 - 43	52.2 - 46	53.2 - 47	56 - 50.5
115 ≤ RPSmin	43	46	47	50.5

Note (1) RPSmin: The lower one between the outdoor speed and the compressor speed

(g) Heating overload protective control

Outdoor unit side

• Models SRK20, 25, 35

1) Operating conditions

When the outdoor air temperature (TH3) is 22°C or higher continues for 30 seconds while the compressor speed other than 0 rps.

2) Detail of operation

- a) Taking the upper limit of compressor speed at 60 rps, if the output speed obtained with the fuzzy calculation exceeds the upper limit, the upper limit value is maintained.
- b) The lower limit of compressor speed is set to 40 rps and even if the calculated result becomes lower than that after fuzzy calculation, the speed is kept to 40 rps. However, when the thermostat OFF, the speed is reduced to 0 rps.
- c) Inching prevention control is activated and inching prevention control is carried out with the minimum speed set at 40 rps.
- d) The outdoor fan speed is set on 2nd speed.

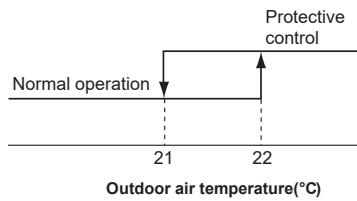

Compressor speed : Upper/lower limit (rps)			Outdoor fan speed
Lower limit		Upper limit	
Range A	Range B	60	2nd
40	Release		

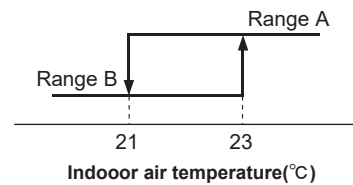

3) Reset conditions

The outdoor air temperature (TH3) is lower than 21°C.

• Model SRK50

1) Operating conditions

When the outdoor air temperature (TH2) is 11°C or higher continues for 30 seconds while the compressor speed other than 0 rps.

2) Detail of operation

- a) Taking the upper limit of compressor speed range at 90 rps, if the output speed obtained with the fuzzy calculation exceeds the upper limit, the upper limit value is maintained.
- b) The lower limit of compressor speed is set to 27 rps and even if the calculated result becomes lower than that after fuzzy calculation, the speed is kept to 27 rps. However, when the thermostat OFF, the speed is reduced to 0 rps.
- c) Inching prevention control is activated and inching prevention control is carried out with the minimum speed set at 27 rps.
- d) Refer to the right table about the outdoor fan speed.

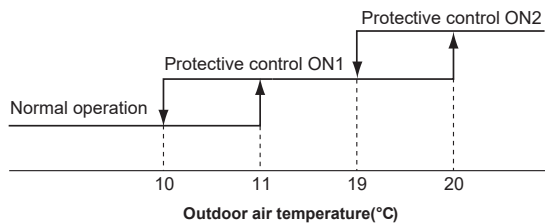

	Compressor speed : Upper/lower limit (rps)			Outdoor fan speed
	Lower limit		Upper limit	
	Range A	Range B		
ON1	27	Release	90	It depends on compressor speed
ON2	27	27	60	

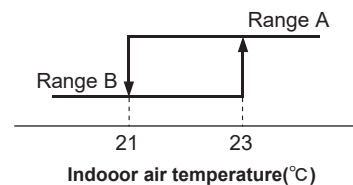

3) Reset conditions

The outdoor air temperature (TH2) is lower than 10°C.

(h) Heating low outdoor temperature protective control

• Models SRK20, 25, 35

(i) Operating conditions

When the outdoor air temperature (TH3) is lower than -2°C or higher continues for 30 seconds while the compressor speed is other than 0 rps.

(ii) Detail of operation

The lower limit compressor speed is change as shown in the figure below.

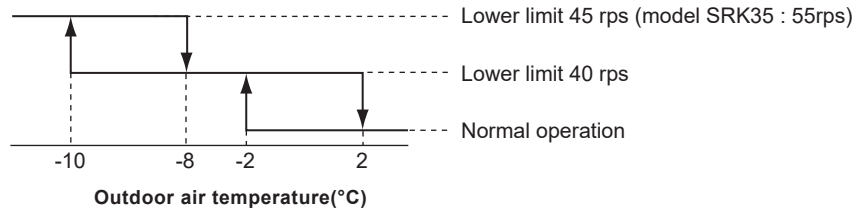

(iii) Reset conditions

When either of the following condition is satisfied

- 1) The outdoor air temperature (TH3) becomes 2°C.
- 2) The compressor speed is 0 rps.

• Model SRK50

(i) Operating conditions

When the outdoor air temperature (TH2) is lower than 4°C or higher than 13°C continues for 30 seconds while the compressor speed is other than 0 rps.

(ii) Detail of operation

The lower limit compressor speed is change as shown in the figure below.

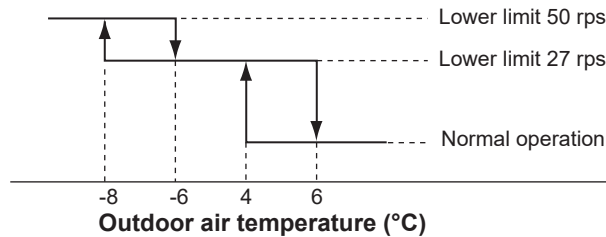

(iii) Reset conditions

When either of the following condition is satisfied

- 1) The outdoor air temperature (TH2) becomes 6°C.
- 2) The compressor speed is 0 rps.

(i) Compressor overheat protection

(i) Purpose

It is designed to prevent deterioration of oil, burnout of motor coil and other trouble resulting from the compressor overheat.

(ii) Detail of operation

- 1) Speeds are controlled with temperature detected by the sensor (TH4 (SRK50 : TH3)) mounted on the discharge pipe.

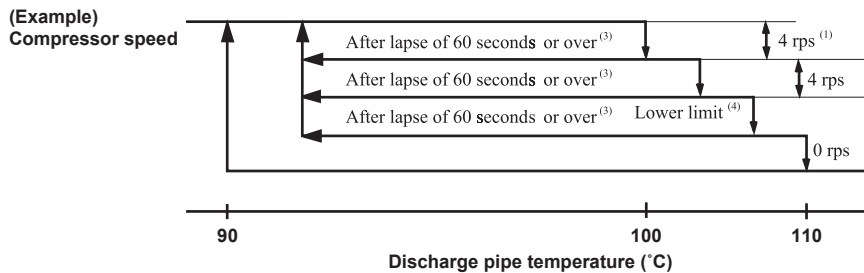

- Notes (1) When the discharge pipe temperature is in the range of 100-110°C, the speed is reduced by 4 rps.
 (2) When the discharge pipe temperature is raised and continues operation for 20 seconds without changing, then the speed is reduced again by 4 rps.
 (3) If the discharge pipe temperature is in the range of 90-100°C even when the compressor speed is maintained for 60 seconds when the temperature is in the range of 90-100°C, the speed is raised by 1 rps and kept at that speed for 60 seconds. This process is repeated until the command speed is reached.
 (4) Lower limit speed

Model	Mode	Cooling	Heating
	Lower limit speed	SRK20 - 35	15 rps
SRK50		20 rps	20 rps

- 2) If the temperature of 110°C is detected by the sensor on the discharge pipe, then the compressor will stop immediately. When the discharge pipe temperature drops and 3 minutes has elapsed, the unit starts again within 1 hour but there is no start at the third time.

(j) Current safe

(i) Purpose

Current is controlled not to exceed the upper limit of the setting operation current.

(ii) Detail of operation

Input current to the converter is monitored with the current sensor fixed on the printed circuit board of the outdoor unit and, if the operation current value reaches the limiting current value, the compressor speed is reduced.

If the mechanism is actuated when the compressor speed is less than 30 rps, the compressor is stopped immediately.

Operation starts again after 3 minutes.

(k) Current cut

(i) Purpose

Inverter is protected from overcurrent.

(ii) Detail of operation

Output current from the inverter is monitored with a shunt resistor and, if the current exceeds the setting value, the compressor is stopped immediately. Operation starts again after 3 minutes.

(l) Outdoor unit failure

This is a function for determining when there is trouble with the outdoor unit during air-conditioning.

The compressor is stopped if any one of the following in item (i), (ii) is satisfied. Once the unit is stopped by this function, it is not restarted.

(i) When the input current is measured at 1 A or less for 3 continuous minutes or more.

(ii) If the outdoor unit sends a 0 rps signal to the indoor unit 3 times or more within 20 minutes of the power being turned on.

(m) Indoor fan motor protection

When the air-conditioner is operating and the indoor fan motor is turned ON, if the indoor fan motor has operated at 300 min⁻¹ or under for more than 30 seconds, the unit enters first in the stop mode and then stops the entire system.

(n) Serial signal transmission error protection

(i) Purpose

Prevents malfunction resulting from error on the indoor ↔ outdoor signals.

(ii) Detail of operation

If the compressor is operating and a serial signal cannot be received from the indoor control with outdoor control having serial signals continues for 7 minutes and 35 seconds, the compressor is stopped.

After the compressor has been stopped, it will be restarted after the compressor start delay if a serial signal can be received again from the indoor control.

(o) Rotor lock

If the motor for the compressor does not turn after it has been started, it is determined that a compressor lock has occurred and the compressor is stopped.

(p) Outdoor fan motor protection

If the outdoor fan motor has operated at 75 min⁻¹ or under for more than 30 seconds, the compressor and fan motor are stopped.

(q) Outdoor fan control at low outdoor temperature**(i) Cooling****1) Operating conditions**

When the outdoor air temperature (TH3 (SRK50 : TH2)) is 22°C or lower continues for 30 seconds while the compressor speed is other than 0 rps.

2) Detail of operation

After the outdoor fan operates at A speed for 60 seconds; the corresponding outdoor heat exchanger temperature shall implement the following controls.

● Value of A

	Outdoor fan
Outdoor temperature > 10°C	2nd speed
Outdoor temperature ≤ 10°C	1st speed

- Outdoor heat exchanger temperature (TH2 (SRK50 : TH1)) ≤ 21°C
After the outdoor fan speed drops (down) to 1 speed for 60 seconds; if the outdoor heat exchanger temperature is lower than 21°C, gradually reduce the outdoor fan speed by 1 speed. (Lower limit 1st speed)
- 21°C < Outdoor heat exchanger temperature (TH2 (SRK50 : TH1)) ≤ 38°C
After the outdoor fan speed maintains at A speed for 20 seconds; if the outdoor heat exchanger temperature is 21°C-38°C, maintain outdoor fan speed.
- Outdoor heat exchanger temperature (TH2 (SRK50 : TH1)) > 38°C
After the outdoor fan speed rises (up) to 1 speed for 60 seconds; if the outdoor heat exchanger temperature is higher than 38°C, gradually increase outdoor fan speed by 1 speed. (Upper limit 3rd speed)

3) Reset conditions

When either of the following conditions is satisfied

- The outdoor air temperature (TH3 (SRK50 : TH2)) is 24°C or higher.
- The compressor command speed is 0 rps.

(ii) Heating**1) Operating conditions**

When the outdoor air temperature (TH3 (SRK50 : TH2)) is 0°C (In addition SRC35 : 6°C) or lower continues for 30 seconds while the compressor command speed is other than 0 rps.

2) Detail of operation

The outdoor fan is stepped up by 2 speed step at each 20 seconds. (Upper limit 8th speed (In addition SRC35 : 1 speed step up corresponding to inverter number of rotations when the outdoor air temperature (TH3) is 6°C or lower))

3) Reset conditions

When either of the following conditions is satisfied

- The outdoor air temperature (TH3 (SRK50 : TH2)) is 2°C (SRC35 : 7°C) or higher.
- The compressor command speed is 0 rps.

(r) Refrigeration cycle system protection**(i) Starting conditions**

- When 5 minutes have elapsed after the compressor ON or the completion of the defrost operation
- Other than the defrost operation
- When, after satisfying the conditions of 1) and 2) above, the compressor speed, room temperature (Th1) and indoor heat exchanger temperature (Th2) have satisfied the conditions in the following table for 5 minutes

Operation mode	Compressor speed (N)	Room temperature (Th1)	Room temperature (Th1)/ Indoor heat exchanger temperature (Th2)
Cooling	50 ≤ N	10 ≤ Th1 ≤ 40	Th1 - 4 < Th2
Heating ⁽¹⁾	50 ≤ N	0 ≤ Th1 ≤ 40	Th2 < Th1 + 6

Note (1) Except that the fan speed is Hi in heating operation.

(ii) Contents of control

- When the conditions of (i) above are satisfied, the compressor stops.
- Error stop occurs when the compressor has stopped 3 times within 60 minutes.

(iii) Reset condition

When the compressor has been turned OFF

10. MAINTENANCE DATA

(1) Cautions

- (a) If you are disassembling and checking an air-conditioner, be sure to turn off the power before beginning. When working on indoor units, let the unit sit for about 1 minute after turning off the power before you begin work. When working on an outdoor unit, there may be an electrical charge applied to the main circuit (electrolytic condenser), so begin work only after discharging this electrical charge (to DC10V or lower).
- (b) When taking out printed circuit boards, be sure to do so without exerting force on the circuit boards or package components.
- (c) When disconnecting and connecting connectors, take hold of the connector housing and do not pull on the lead wires.

(2) Items to check before troubleshooting

- (a) Have you thoroughly investigated the details of the trouble which the customer is complaining about?
- (b) Is the air-conditioner running? Is it displaying any self-diagnosis information?
- (c) Is a power source with the correct voltage connected?
- (d) Are the control lines connecting the indoor and outdoor units wired correctly and connected securely?
- (e) Is the outdoor unit's service valve open?

(3) Troubleshooting procedure (If the air-conditioner does not run at all)

If the air-conditioner does not run at all, diagnose the trouble using the following troubleshooting procedure. If the air-conditioner is running but breaks down, proceed to troubleshooting step (4).

Important When all the following conditions are satisfied, we say that the air-conditioner will not run at all.

- (a) The RUN light does not light up.
- (b) The flaps do not open.
- (c) The indoor unit fan motors do not run.
- (d) The self-diagnosis display does not function.

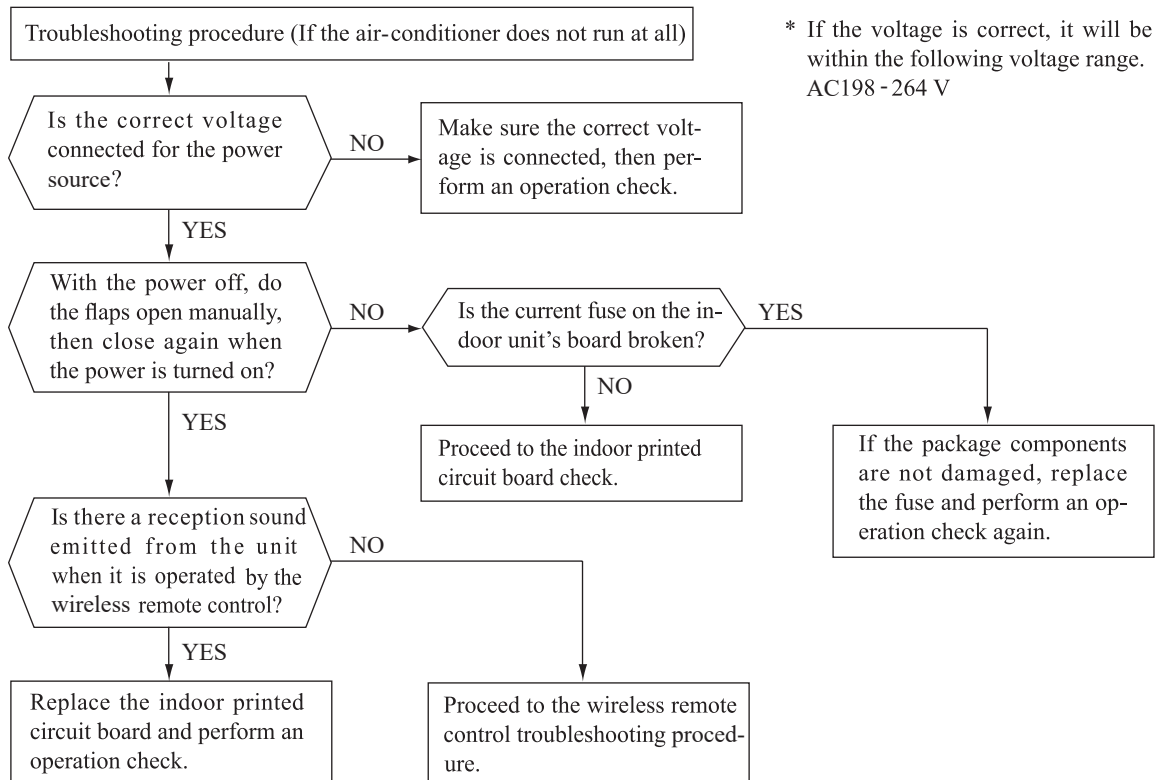

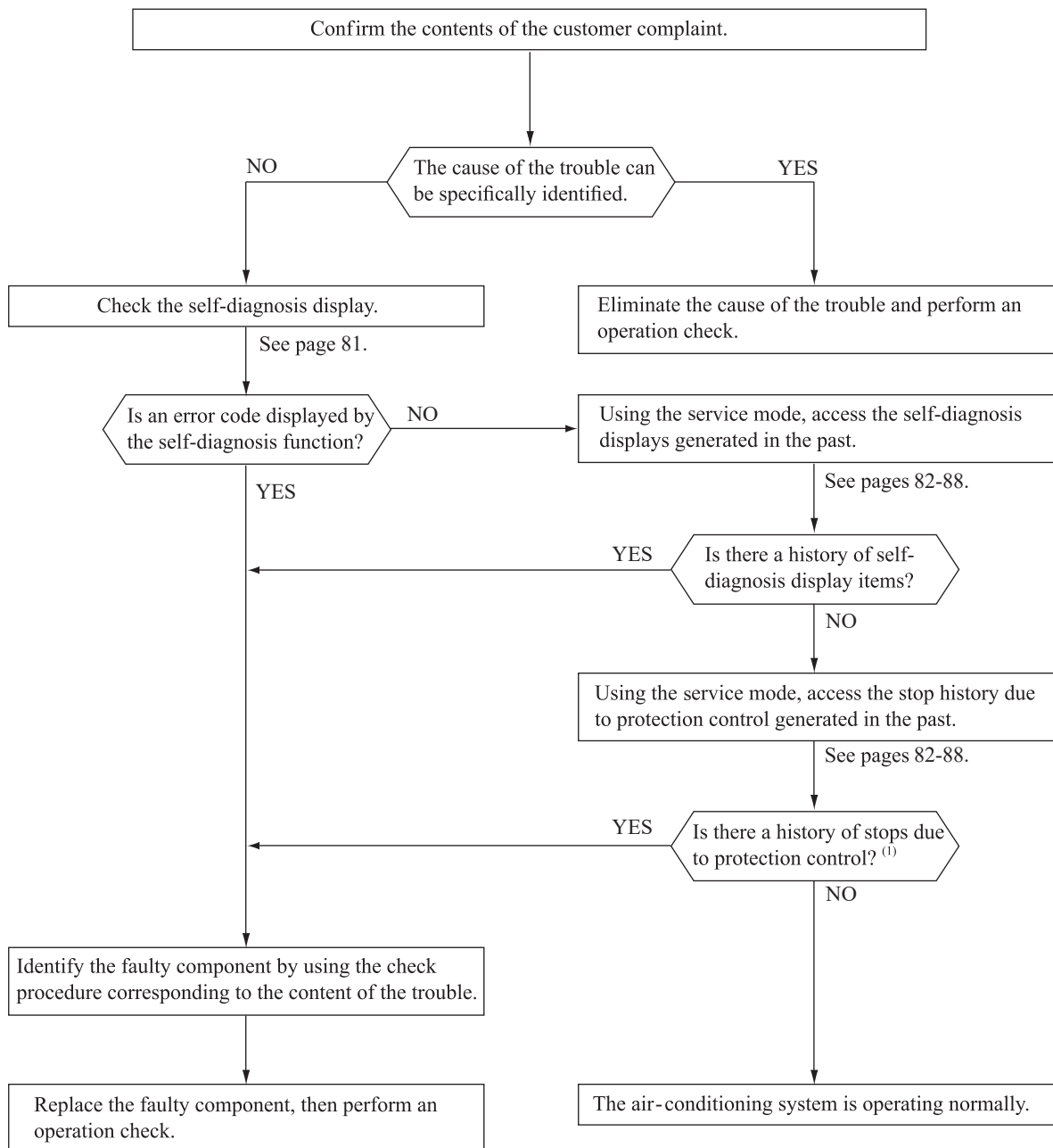
(4) Troubleshooting procedure (If the air-conditioner runs)

Note (1) Even in cases where only intermittent stop data are generated, the air-conditioning system is normal. However, if the same protective operation recurs repeatedly (3 or more times), it will lead to customer complaints. Judge the conditions in comparison with the contents of the complaints.

(5) Self-diagnosis table

When this air-conditioner performs an emergency stop, the reason why the emergency stop occurred is displayed by the flashing of display lights. If the air-conditioner is operated using the remote control 3 minutes or more after the emergency stop, the trouble display stops and the air-conditioner resumes operation. ⁽¹⁾

Indoor unit display panel		Wired ⁽²⁾ remote control display	Description of trouble	Cause	Display (flashing) condition
RUN light	TIMER light				
1-time flash	ON	—	Heat exchanger sensor 1 error	<ul style="list-style-type: none"> • Broken heat exchanger sensor 1 wire, poor connector connection • Indoor unit PCB is faulty 	When a heat exchanger sensor 1 wire disconnection is detected while operation is stopped. (If a temperature of -28°C or lower is detected for 15 seconds, it is judged that the wire is disconnected.) (Not displayed during operation.)
2-time flash	ON	—	Room temperature sensor error	<ul style="list-style-type: none"> • Broken room temperature sensor wire, poor connector connection • Indoor unit PCB is faulty 	When a room temperature sensor wire disconnection is detected while operation is stopped. (If a temperature of -45°C or lower is detected for 15 seconds, it is judged that the wire is disconnected.) (Not displayed during operation.)
3-time flash	ON	—	Heat exchanger sensor 2 error	<ul style="list-style-type: none"> • Broken heat exchanger sensor 2 wire, poor connector connection • Indoor unit PCB is faulty 	When a heat exchanger sensor 2 wire disconnection is detected while operation is stopped. (If a temperature of -28°C or lower is detected for 15 seconds, it is judged that the wire is disconnected.) (Not displayed during operation.)
6-time flash	ON	E 16	Indoor fan motor error	<ul style="list-style-type: none"> • Defective fan motor, poor connector connection 	When conditions for turning the indoor unit's fan motor on exist during air-conditioner operation, an indoor unit fan motor speed of 300min^{-1} or lower is measured for 30 seconds or longer. (The air-conditioner stops.)
Keeps flashing	1-time flash	E 38	Outdoor air temperature sensor error	<ul style="list-style-type: none"> • Broken outdoor air temp. sensor wire, poor connector connection • Outdoor unit PCB is faulty 	-55°C or lower is detected for 5 seconds continuously 3 times within 40 minutes after initial detection of this anomalous temperature. Or -55°C or higher is detected for within 20 seconds after power ON. (The compressor is stopped.)
Keeps flashing	2-time flash	E 37	Outdoor heat exchanger sensor error	<ul style="list-style-type: none"> • Broken heat exchanger sensor wire, poor connector connection • Outdoor unit PCB is faulty 	-55°C or lower is detected for 5 seconds continuously 3 times within 40 minutes after initial detection of this anomalous temperature. Or -55°C or higher is detected for within 20 seconds after power ON. (The compressor is stopped.)
Keeps flashing	4-time flash	E 39	Discharge pipe sensor error	<ul style="list-style-type: none"> • Broken discharge pipe sensor wire, poor connector connection • Outdoor unit PCB is faulty 	-25°C or lower is detected for 5 seconds continuously 3 times within 40 minutes after initial detection of this anomalous temperature. (The compressor is stopped.)
ON	1-time flash	E 42	Current cut	<ul style="list-style-type: none"> • Compressor locking, open phase on compressor output, short circuit on power transistor, service valve is closed 	The compressor output current exceeds the set value during compressor start. (The air-conditioner stops.)
ON	2-time flash	E 59	Trouble of outdoor unit	<ul style="list-style-type: none"> • Broken compressor wire • Compressor blockage 	When there is an emergency stop caused by trouble in the outdoor unit, or the input current value is found to be lower than the set value. (The air-conditioner stops.)
ON	3-time flash	E 58	Current safe stop	<ul style="list-style-type: none"> • Overload operation • Overcharge • Compressor locking 	When the compressor command speed is lower than the set value and the current safe has operated. (the compressor stops)
ON	4-time flash	E 51	Power transistor error	<ul style="list-style-type: none"> • Broken power transistor 	When the power transistor is judged breakdown while compressor starts. (The compressor is stopped.)
ON	5-time flash	E 36	Over heat of compressor	<ul style="list-style-type: none"> • Gas shortage, defective discharge pipe sensor, service valve is closed 	When the value of the discharge pipe sensor exceeds the set value. (The air-conditioner stops.)
ON	6-time flash	E 5	Error of signal transmission	<ul style="list-style-type: none"> • Defective power source, Broken signal wire, defective indoor/outdoor unit PCB 	When there is no signal between the indoor unit PCB and outdoor unit PCB for 10 seconds or longer (when the power is turned on), or when there is no signal for 7 minute 35 seconds or longer (during operation) (the compressor is stopped).
ON	7-time flash	E 48	Outdoor fan motor error	<ul style="list-style-type: none"> • Defective fan motor, poor connector connection 	When the outdoor unit's fan motor speed continues for 30 seconds or longer at 75min^{-1} or lower. (3 times) (The air-conditioner stops.)
ON	Keeps flashing	E 35	Cooling high pressure protecton	<ul style="list-style-type: none"> • Overload operation, overcharge • Broken outdoor heat exchange sensor wire • Service valve is closed 	When the value of the outdoor heat exchanger sensor exceeds the set value.
2-time flash	2-time flash	E 60	Rotor lock	<ul style="list-style-type: none"> • Defective compressor • Open phase on compressor • Defective outdoor unit PCB 	If the compressor motor's magnetic pole positions cannot be correctly detected when the compressor starts. (The air-conditioner stops.)
4-time flash	ON	—	Trouble of wireless LAN interface	<ul style="list-style-type: none"> • Defective wireless LAN interface boards, poor connector connection 	When normal data cannot be received from wireless LAN interface for two minutes continuously
5-time flash	ON	E 47	Active filter voltage error	<ul style="list-style-type: none"> • Defective active filter 	When the wrong voltage connected for the power source. When the outdoor unit PCB is faulty
7-time flash	ON	E 57	Refrigeration cycle system protective control	<ul style="list-style-type: none"> • Service valve is closed. • Refrigerant is insufficient 	When refrigeration cycle system protective control operates.
7-time flash	1-time flash	E 40	Service valve (gas side) closed operation	<ul style="list-style-type: none"> • Service valve (gas side) closed • Defective outdoor unit PCB 	If the output current of inverter exceeds the specifications, it makes the compressor stopping. (In heating mode). After 3-minute delay, the compressor restarts, but if this anomaly occurs 2 times within 20 minutes after the initial detection.
—	—	E 1	Error of wired remote control wiring	<ul style="list-style-type: none"> • Broken wired remote control wire, defective indoor unit PCB 	The wired remote control wire Y is open. The wired remote control wires X and Y are reversely connected. Noise is penetrating the wired remote control lines. The wired remote control or indoor unit PCB is faulty. (The communications circuit is faulty.)

Notes (1)The air-conditioner cannot be restarted using the remote control for 3 minutes after operation stops.

(2)The wired remote control is option parts.

(6) Service mode (Trouble mode access function)

This air-conditioner is capable of recording error displays and protective stops (service data) which have occurred in the past. If self-diagnosis displays cannot be confirmed, it is possible to get a grasp of the conditions at the time trouble occurred by checking these service data.

(a) Explanation of terms

Term	Explanation
Service mode	The service mode is the mode where service data are displayed by flashing of the display lights when the operations in item (b) below are performed with the indoor control.
Service data	These are the contents of error displays and protective stops which occurred in the past in the air-conditioner system. Error display contents and protective stop data from past anomalous operations of the air-conditioner system are saved in the indoor unit control's non-volatile memory (memory which is not erased when the power goes off). There are two types of data, self-diagnosis data and stop data, described below.
Self-diagnosis data	These are the data which display the reason why a stop occurred when an error display (self-diagnosis display) occurred in an indoor unit. Data are recorded for up to 5 previous occurrences. Data which are older than the 5th previous occurrence are erased. In addition, data on the temperature of each sensor (room temperature, indoor heat exchanger, outdoor heat exchanger, outdoor air temperature, discharge pipe), remote control information (operation switching, fan speed switching) are recorded when trouble occurs, so more detailed information can be checked.
Stop data	These are the data which display the reason by a stop occurred when the air-conditioning system performed protective stops, etc. in the past. Even if stop data alone are generated, the system restarts automatically. (After executing the stop mode while the display is normal, the system restarts automatically.) Data for up to 10 previous occasions are stored. Data older than the 10th previous occasion are erased. (Important) In cases where transient stop data only are generated, the air-conditioner system may still be normal. However, if the same protective stop occurs frequently (3 or more times), it could lead to customer complaints.

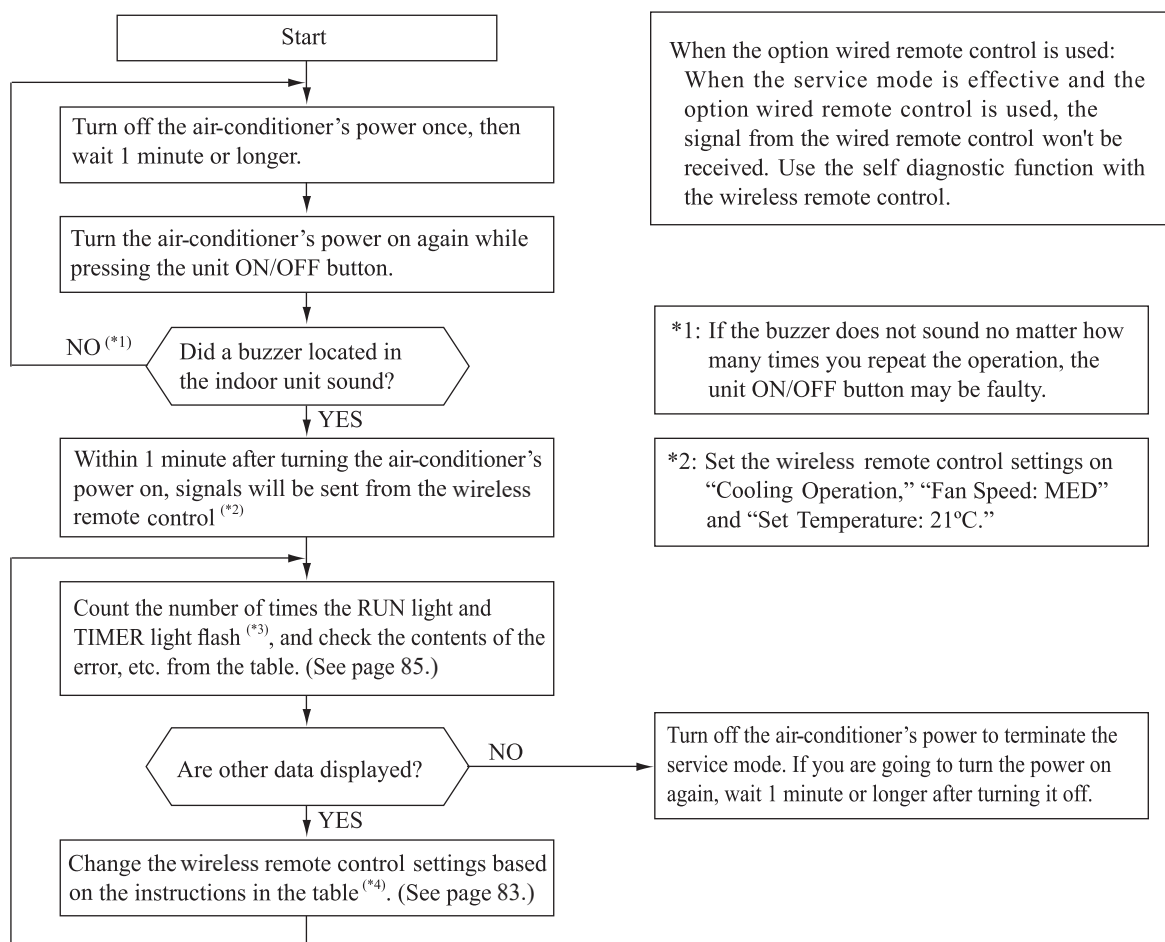
(b) Service mode display procedure

- *3: To count the number of flashes in the service mode, count the number of flashes after the light lights up for 1.5 second initially (start signal). (The time that the light lights up for 1.5 second (start signal) is not counted in the number of flashes.)

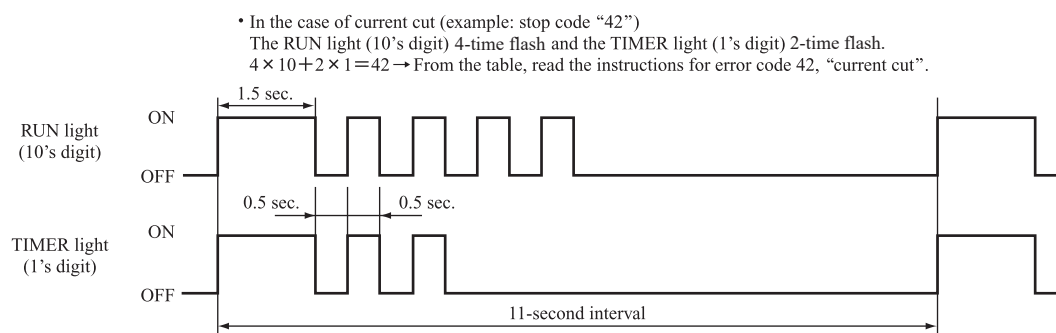

- *4: When in the service mode, when the wireless remote control settings (operation mode, fan speed mode, temperature setting) are set as shown in the following table and sent to the air-conditioner unit, the unit switches to display of service data.

(i) Self-diagnosis data

What are Self-diagnosis Data?

These are control data (reasons for stops, temperature at each sensor, wireless remote control information) from the time when there were error displays (abnormal stops) in the indoor unit in the past. Data from up to 5 previous occasions are stored in memory. Data older than the 5th previous occasion are erased. The temperature setting indicates how many occasions previous to the present setting the error display data are and the operation mode and fan speed mode data show the type of data.

Wireless remote control setting		Contents of output data
Operation mode	Fan speed mode	
Cooling	MED	Displays the reason for stopping display in the past (error code).
	HI	Displays the room temperature sensor temperature at the time the error code was displayed in the past.
	AUTO	Displays the indoor heat exchanger sensor temperature at the time the error code was displayed in the past.
Heating	LO	Displays the wireless remote control information at the time the error code was displayed in the past.
	MED	Displays the outdoor air temperature sensor temperature at the time the error code was displayed in the past.
	HI	Displays the outdoor heat exchanger sensor temperature at the time the error code was displayed in the past.
	AUTO	Displays the discharge pipe sensor temperature at the time the error code was displayed in the past.

Wireless remote control setting	Indicates the number of occasions previous to the present the error display data are from.
Temperature setting	
21°C	1 time previous (previous time)
22°C	2 times previous
23°C	3 times previous
24°C	4 times previous
25°C	5 times previous

Only for indoor heat exchanger sensor 2

Wireless remote control setting	Indicates the number of occasions previous to the present the error display data are from.
Temperature setting	
26°C	1 time previous (previous time)
27°C	2 times previous
28°C	3 times previous
29°C	4 times previous
30°C	5 times previous

(Example)

Wireless remote control setting			Displayed data
Operation mode	Fan speed mode	Temperature setting	
Cooling	MED	21°C	Displays the reason for the stop (error code) the previous time an error was displayed.
		22°C	Displays the reason for the stop (error code) 2 times previous when an error was displayed.
		23°C	Displays the reason for the stop (error code) 3 times previous when an error was displayed.
		24°C	Displays the reason for the stop (error code) 4 times previous when an error was displayed.
		25°C	Displays the reason for the stop (error code) 5 times previous when an error was displayed.

(ii) Stop data

Wireless remote control setting			Displayed data
Operation mode	Fan speed mode	Temperature setting	
Cooling	LO	21°C	Displays the reason for the stop (stop code) the previous time when the air-conditioner was stopped by protective stop control.
		22°C	Displays the reason for the stop (stop code) 2 times previous when the air-conditioner was stopped by protective stop control.
		23°C	Displays the reason for the stop (stop code) 3 times previous when the air-conditioner was stopped by protective stop control.
		24°C	Displays the reason for the stop (stop code) 4 times previous when the air-conditioner was stopped by protective stop control.
		25°C	Displays the reason for the stop (stop code) 5 times previous when the air-conditioner was stopped by protective stop control.
		26°C	Displays the reason for the stop (stop code) 6 times previous when the air-conditioner was stopped by protective stop control.
		27°C	Displays the reason for the stop (stop code) 7 times previous when the air-conditioner was stopped by protective stop control.
		28°C	Displays the reason for the stop (stop code) 8 times previous when the air-conditioner was stopped by protective stop control.
		29°C	Displays the reason for the stop (stop code) 9 times previous when the air-conditioner was stopped by protective stop control.
		30°C	Displays the reason for the stop (stop code) 10 times previous when the air-conditioner was stopped by protective stop control.

(c) **Error code, stop code table** (Assignment of error codes and stop codes is done in common for all models.)

Number of flashes when in service mode		Stop code or Error code	Error content	Cause	Occurrence conditions	Error display	Auto recovery
RUN light (10's digit)	TIMER light (1's digit)						
OFF	OFF	0	Normal	—	—	—	—
	1-time flash	01	Error of wired remote control wiring (When wired remote control was connected) (When wireless LAN interface was connected, refer to page 81.)	Broken wired remote control wire. defective indoor unit PCB	The wired remote control wire Y is open. The wired remote control wires X and Y are reversely connected. Noise is penetrating the wired remote control lines. The wired remote control or indoor unit PCB is faulty.	—	○
	5-time flash	05	Can not receive signals for 35 seconds (if communications have recovered)	Power source is faulty Power source cables and signal lines are improperly wired. Indoor or outdoor unit PCB are faulty	When 35 seconds passes without communications signals from either the outdoor unit or the indoor unit being detected correctly.	○	—
3-time flash	5-time flash	35	Cooling high pressure control	Cooling overload operation. Outdoor unit fan speed drops. Outdoor heat exchanger sensor is short circuit.	When the outdoor heat exchanger sensor's value exceeds the set value.	○ (5 times)	○
	6-time flash	36	Compressor overheat 110°C	Refrigerant is insufficient. Discharge pipe sensor is faulty. Service valve is closed.	When the discharge pipe sensor's value exceeds the set value.	○ (2 times)	○
	7-time flash	37	Outdoor heat exchanger temperature sensor is abnormal	Outdoor heat exchanger sensor wire is disconnected. Connector connections are poor. Outdoor unit PCB is faulty	-55°C or lower is detected for 5 seconds continuously 3 times within 40 minutes after initial detection of this anomalous temperature. Or -55°C higher is detected for 5 seconds continuously within 20 seconds after power ON.	○ (3 times)	○
	8-time flash	38	Outdoor air temperature sensor is abnormal	Outdoor air temperature sensor wire is disconnected. Connector connections are poor. Outdoor unit PCB is faulty	-55°C or lower is detected for 5 seconds continuously 3 times within 40 minutes after initial detection of this anomalous temperature. Or -55°C higher is detected for 5 seconds continuously within 20 seconds after power ON.	○ (3 times)	○
	9-time flash	39	Discharge pipe temperature sensor is abnormal (anomalous stop)	Discharge pipe sensor wire is disconnected. Connector connections are poor. Outdoor unit PCB is faulty	-25°C or lower is detected for 5 seconds continuously 3 times within 40 minutes after initial detection of this anomalous temperature.	○ (3 times)	○
4-time flash	OFF	40	Service valve (gas side) closed operation	Service valve (gas side) closed Outdoor unit PCB is faulty.	If the inverter output current value exceeds the setting value within 80 seconds after the compressor ON in the heating mode, the compressor stops.	○ (2 times)	○
	2-time flash	42	Current cut	Compressor lock. Compressor wiring short circuit. Compressor output is open phase. Outdoor unit PCB is faulty Service valve is closed. Electronic expansion valve is faulty. Compressor is faulty.	Compressor start fails 42 times in succession and the reason for the final failure is current cut.	○ (2 times)	○
	7-time flash	47	Active filter voltage error	Defective active filter	When the wrong voltage connected for the power source. When the outdoor unit PCB is faulty.	○	—
	8-time flash	48	Outdoor unit's fan motor is abnormal	Outdoor fan motor is faulty. Connector connections are poor. Outdoor unit PCB is faulty	When a fan speed of 75 min ⁻¹ or lower continues for 30 seconds or longer.	○ (3 times)	○
5-time flash	1-time flash	51	Short-circuit in the power transistor (high side) Current cut circuit breakdown	Outdoor unit PCB is faulty Power transistor is damaged.	When it is judged that the power transistor was damaged at the time the compressor started.	○	—
	7-time flash	57	Refrigeration cycle system protective control	Service valve is closed. Refrigerant is insufficient.	When refrigeration cycle system protective control operates.	○ (3 times)	○
	8-time flash	58	Current safe	Refrigerant is overcharge. Compressor lock. Overload operation.	When there is a current safe stop during operation.	—	○
	9-time flash	59	Compressor wiring is unconnection Voltage drop Low speed protective control	Compressor wiring is disconnected. Power transistor is damaged. Power source construction is defective. Outdoor unit PCB is faulty Compressor is faulty.	When the current is 1A or less at the time the compressor started. When the power source voltage drops during operation. When the compressor command speed is lower than 32 rps for 60 minutes.	○	○
6-time flash	OFF	60	Rotor lock	Compressor is faulty. Compressor output is open phase. Electronic expansion valve is faulty. Overload operation. Outdoor unit PCB is faulty	After the compressor starts, when the compressor stops due to rotor lock.	○ (2 times)	○
	1-time flash	61	Connection lines between the indoor and outdoor units are faulty	Connection lines are faulty. Indoor or outdoor unit PCB are faulty	When 10 seconds passes after the power is turned on without communications signals from the indoor or outdoor unit being detected correctly.	○	—
	2-time flash	62	Serial transmission error	Indoor or outdoor unit PCB are faulty Noise is causing faulty operation.	When 7 minute 35 seconds passes without communications signals from either the outdoor unit or the indoor unit being detected correctly.	○	—
8-time flash	OFF	80	Indoor fan motor is abnormal	Indoor fan motor is faulty. Connector connections are poor. Indoor unit PCB is faulty	When the indoor unit's fan motor is detected to be running at 300min ⁻¹ or lower speed with the fan motor in the ON condition while the air-conditioner is running.	○	—
	2-time flash	82	Indoor heat exchanger temperature sensor is abnormal (anomalous stop)	Indoor heat exchanger sensor wire is disconnected. Connector connections are poor.	When a temperature of -28°C or lower is sensed continuously for 40 minutes during heating operation. (the compressor stops).	○	—
	4-time flash	84	Anti-condensation control	High humidity condition.	Anti-condensation prevention control is operating.	—	○
	5-time flash	85	Anti-frost control	Indoor unit fan speed drops. Indoor heat exchanger sensor is broken wire.	When the anti-frost control operates and the compressor stops during cooling operation.	—	○
	6-time flash	86	Heating high pressure control	Heating overload operation. Indoor unit fan speed drops. Indoor heat exchanger sensor is short circuit.	When high pressure control operates during heating operation and the compressor stops.	—	○

Notes (1) The number of flashes when in the service mode do not include the 1.5 second period when the lights light up at first (start signal). (See the example shown below.)

- In the case of current cut (example: stop code “42”) The RUN light (10’s digit) 4-time flash and the TIMER light (1’s digit) 2-time flash. $4 \times 10 + 2 \times 1 = 42 \rightarrow$ From the table, read the instructions for error code 42, “current cut”.

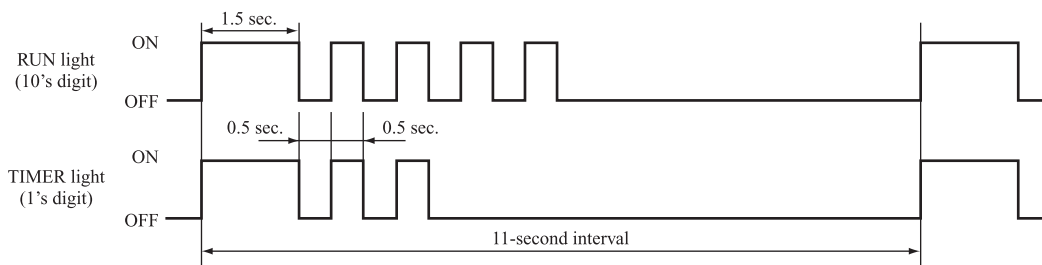

- (2) Error display: – Is not displayed. (automatic recovery only)
 ○ Displayed.
 If there is a () displayed, the error display shows the number of times that an auto recovery occurred for the same reason has reached the number of times in ().
 If no () is displayed, the error display shows that the trouble has occurred once.
- (3) Auto Recovery: – Does not occur
 ○ Auto recovery occurs.

(d) Operation mode, Fan speed mode information tables

(i) Operation mode

Display pattern when in service mode	Operation mode when there is an abnormal stop
RUN light (10's digit)	
—	AUTO
1-time flash	DRY
2-time flash	COOL
3-time flash	FAN
4-time flash	HEAT

(ii) Fan speed mode

Display pattern when in service mode	Fan speed mode when there is an abnormal stop
TIMER light (1's digit)	
—	AUTO
2-time flash	HI
3-time flash	MED
4-time flash	LO
5-time flash	ULO
6-time flash	HI POWER
7-time flash	ECONO

* If no data are recorded (error code is normal), the information display in the operation mode and fan speed mode becomes as follows.

Mode	Display when error code is normal
Operation mode	AUTO
Fan speed mode	AUTO

(Example): Operation mode: COOL, Fan speed mode: HI

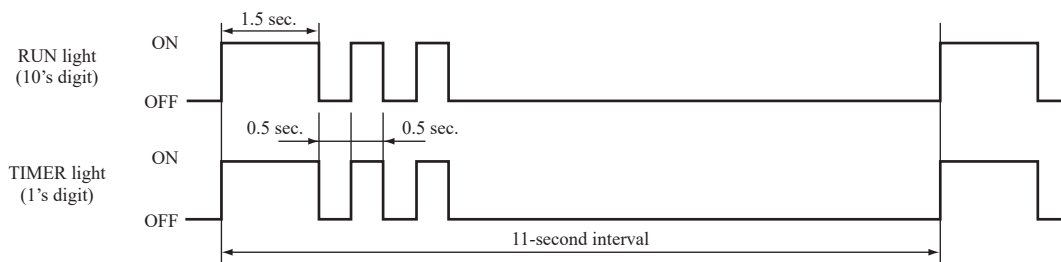

(e) Temperature information

(i) Room temperature sensor, indoor heat exchanger temperature sensor, outdoor air temperature sensor, outdoor heat exchanger temperature sensor

Unit: °C

Buzzer sound	TIMER light (1's digit)	RUN light (10's digit)	0	1	2	3	4	5	6	7	8	9
			Yes (sounds for 0.1 second)	6	-60	-61	-62	-63	-64			
5	-50	-51		-52	-53	-54	-55	-56	-57	-58	-59	
4	-40	-41		-42	-43	-44	-45	-46	-47	-48	-49	
3	-30	-31		-32	-33	-34	-35	-36	-37	-38	-39	
2	-20	-21		-22	-23	-24	-25	-26	-27	-28	-29	
1	-10	-11		-12	-13	-14	-15	-16	-17	-18	-19	
0	/	-1		-2	-3	-4	-5	-6	-7	-8	-9	
No (does not sound)	0	0		1	2	3	4	5	6	7	8	9
	1	10	11	12	13	14	15	16	17	18	19	
	2	20	21	22	23	24	25	26	27	28	29	
	3	30	31	32	33	34	35	36	37	38	39	
	4	40	41	42	43	44	45	46	47	48	49	
	5	50	51	52	53	54	55	56	57	58	59	
	6	60	61	62	63	64	65	66	67	68	69	
	7	70	71	72	73	74	75	76	77	78	79	
	8	80	81	82	83	84	85	86	87	88	89	
	9	90	91	92	93	94	95	96	97	98	99	

* If no data are recorded (error code is normal), the display for each temperature information becomes as shown below.

Sensor name	Sensor value displayed when the error code is normal
Room temperature sensor	-64°C
Indoor heat exchanger temperature sensor	-64°C
Outdoor air temperature sensor	-64°C
Outdoor heat exchanger temperature sensor	-64°C

(Example) Outdoor heat exchanger temperature data: “-9°C”

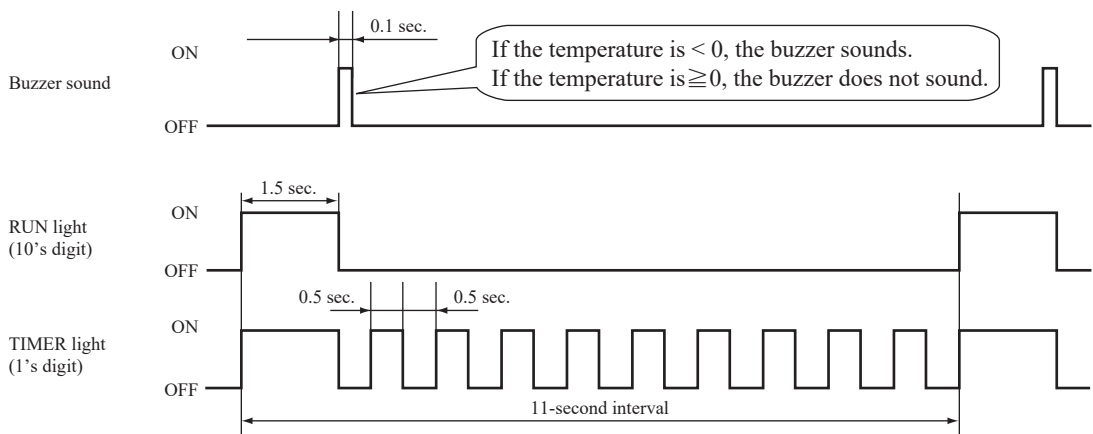

(ii) Discharge pipe temperature sensor

Unit: °C

Buzzer sound	TIMER light (1's digit)	RUN light (10's digit)	0	1	2	3	4	5	6	7	8	9
			Yes (sounds for 0.1 second)	3	-60	-62	-64					
2	-40	-42		-44	-46	-48	-50	-52	-54	-56	-58	
1	-20	-22		-24	-26	-28	-30	-32	-34	-36	-38	
0	/	-2		-4	-6	-8	-10	-12	-14	-16	-18	
No (does not sound)	0	0	2	4	6	8	10	12	14	16	18	
	1	20	22	24	26	28	30	32	34	36	38	
	2	40	42	44	46	48	50	52	54	56	58	
	3	60	62	64	66	68	70	72	74	76	78	
	4	80	82	84	86	88	90	92	94	96	98	
	5	100	102	104	106	108	110	112	114	116	118	
	6	120	122	124	126	128	130	132	134	136	138	
	7	140	142	144	146	148	150					

* If no data are recorded (error code is normal), the display for each temperature information becomes as shown below.

Sensor name	Sensor value displayed when the error code is normal
Discharge pipe temperature sensor	-64°C

(Example) Discharge pipe temperature data: "122°C"

* In the case of discharge pipe data, multiply the reading value by 2. (Below, 61 x 2 = "122°C")

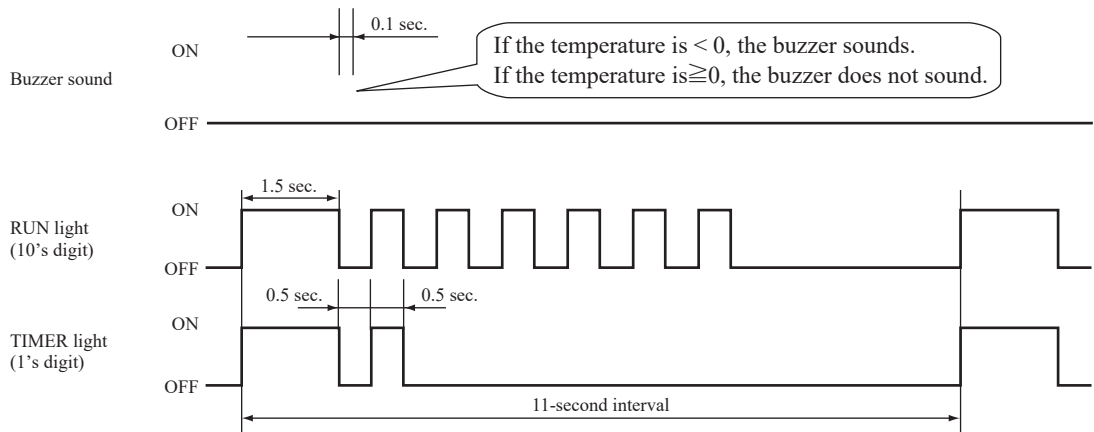

Service data record form

Customer		Model					
Date of investigation							
Machine name							
Content of complaint							
Wireless remote control settings			Content of displayed data	Display results			Display content
Temperature setting	Operation mode	Fan speed mode		Buzzer (Yes/No.)	RUN light (Times)	TIMER light (Times)	
21	Cooling	MED	Error code on previous occasion	/			
		HI	Room temperature sensor on previous occasion				
		AUTO	Indoor heat exchanger sensor 1 on previous occasion				
	Heating	LO	Wireless remote control information on previous occasion	/			
		MED	Outdoor air temperature sensor on previous occasion				
		HI	Outdoor heat exchanger sensor on previous occasion				
	AUTO	Discharge pipe sensor on previous occasion					
26	Cooling	AUTO	Indoor heat exchanger sensor 2 on previous occasion				
22	Cooling	MED	Error code on second previous occasion	/			
		HI	Room temperature sensor on second previous occasion				
		AUTO	Indoor heat exchanger sensor 1 on second previous occasion				
	Heating	LO	Wireless remote control information on second previous occasion	/			
		MED	Outdoor air temperature sensor on second previous occasion				
		HI	Outdoor heat exchanger sensor on second previous occasion				
	AUTO	Discharge pipe sensor on second previous occasion					
27	Cooling	AUTO	Indoor heat exchanger sensor 2 on second occasion				
23	Cooling	MED	Error code on third previous occasion	/			
		HI	Room temperature sensor on third previous occasion				
		AUTO	Indoor heat exchanger sensor 1 on third previous occasion				
	Heating	LO	Wireless remote control information on third previous occasion	/			
		MED	Outdoor air temperature sensor on third previous occasion				
		HI	Outdoor heat exchanger sensor on third previous occasion				
	AUTO	Discharge pipe sensor on third previous occasion					
28	Cooling	AUTO	Indoor heat exchanger sensor 2 on third occasion				
24	Cooling	MED	Error code on fourth previous occasion	/			
		HI	Room temperature sensor on fourth previous occasion				
		AUTO	Indoor heat exchanger sensor 1 on fourth previous occasion				
	Heating	LO	Wireless remote control information on fourth previous occasion	/			
		MED	Outdoor air temperature sensor on fourth previous occasion				
		HI	Outdoor heat exchanger sensor on fourth previous occasion				
	AUTO	Discharge pipe sensor on fourth previous occasion					
29	Cooling	AUTO	Indoor heat exchanger sensor 2 on fourth occasion				
25	Cooling	MED	Error code on fifth previous occasion	/			
		HI	Room temperature sensor on fifth previous occasion				
		AUTO	Indoor heat exchanger sensor 1 on fifth previous occasion				
	Heating	LO	Wireless remote control information on fifth previous occasion	/			
		MED	Outdoor air temperature sensor on fifth previous occasion				
		HI	Outdoor heat exchanger sensor on fifth previous occasion				
	AUTO	Discharge pipe sensor on fifth previous occasion					
30	Cooling	AUTO	Indoor heat exchanger sensor 2 on fifth occasion				
21	Cooling	LO	Stop code on previous occasion				
22			Stop code on second previous occasion				
23			Stop code on third previous occasion				
24			Stop code on fourth previous occasion				
25			Stop code on fifth previous occasion				
26			Stop code on sixth previous occasion				
27			Stop code on seventh previous occasion				
28			Stop code on eighth previous occasion				
29			Stop code on ninth previous occasion				
30			Stop code on tenth previous occasion				
Judgment							Examiner
Remarks							

Note (1) In the case of indoor heat exchanger sensor 2, match from 26 to 30 the temperature setting of wireless remote control. (Refer to page 83.)

(7) Inspection procedures corresponding to detail of trouble

Sensor error

[Broken sensor wire, connector poor connection]

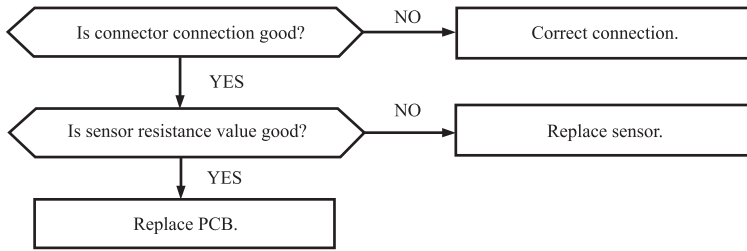

◆ Discharge pipe temperature sensor characteristics

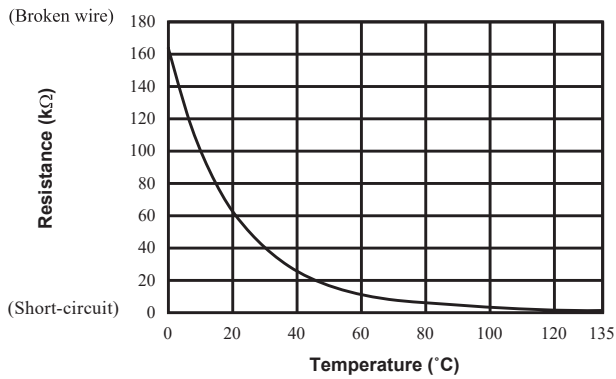

◆ Temperature sensor characteristics (Room temperature, indoor heat exchanger temperature, outdoor heat exchanger temperature, outdoor air temperature)

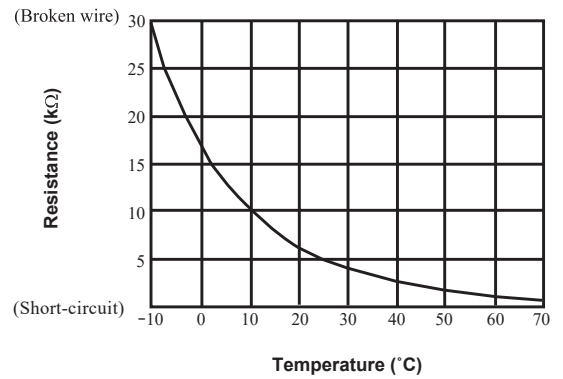

Indoor fan motor error

[Defective fan motor, connector poor connection, defective indoor unit PCB]

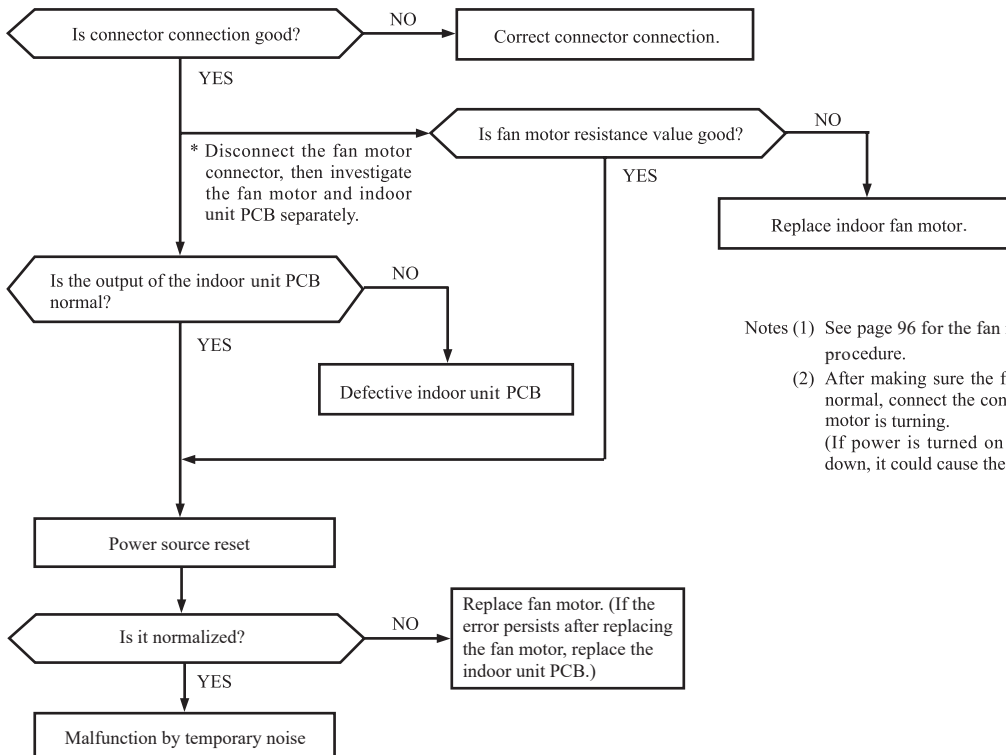

Notes (1) See page 96 for the fan motor and indoor unit PCB check procedure.

(2) After making sure the fan motor and indoor unit PCB are normal, connect the connectors and confirm that the fan motor is turning.
(If power is turned on while one or the other is broken down, it could cause the other to break down also.)

Current cut

[Compressor lock, Compressor wiring short-circuit, Compressor output is open phase, Outdoor unit PCB is faulty, Service valve is closed, EEV is faulty, Compressor faulty.]

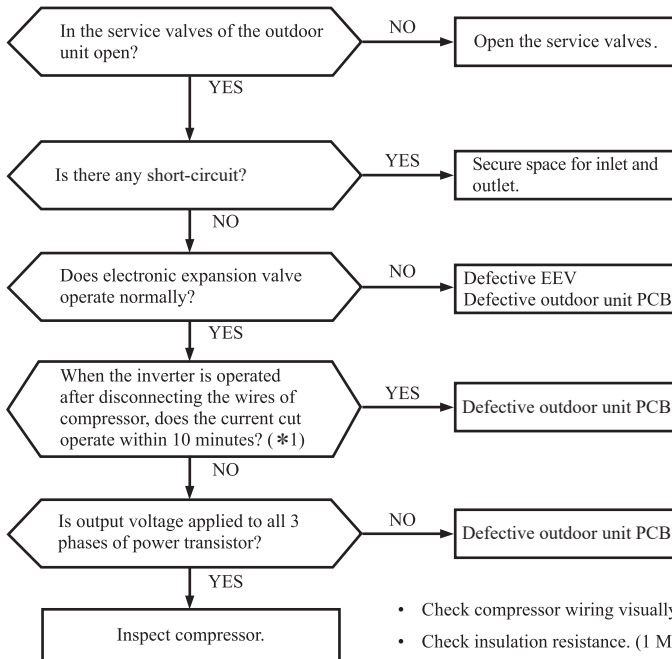

For inspection of electronic expansion valve, see page 100.

*1 If it is normal, it is the rotor lock problem.

- Check compressor wiring visually.
- Check insulation resistance. (1 MΩ or over)
- Check resistance between terminals.

⎓ If check results are normal, compressor is locked.

SRC20, 25 : 4.428Ω (U-V, V-W, U-W) or more at 20°C

SRC35 : 1.703Ω (U-V, V-W, U-W) or more at 20°C

SRC50 : 1.728Ω (U-V), 1.705Ω (V-W), 1.761Ω (W-U) or more at 20°C

Current safe stop

[Overload operation, compressor lock, overcharge]

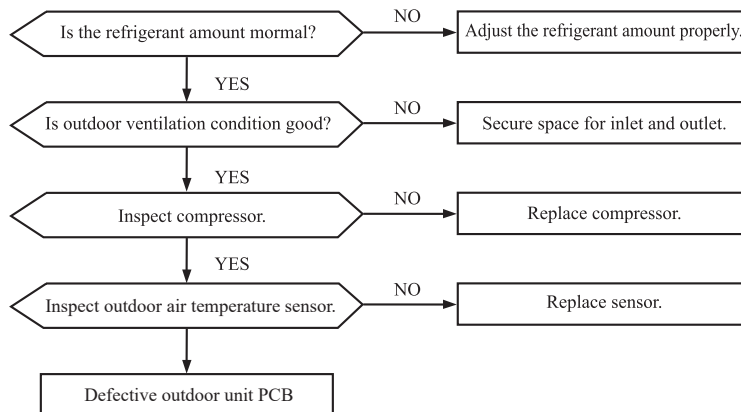

Overheat of compressor

[Gas shortage, defective discharge pipe temperature sensor]

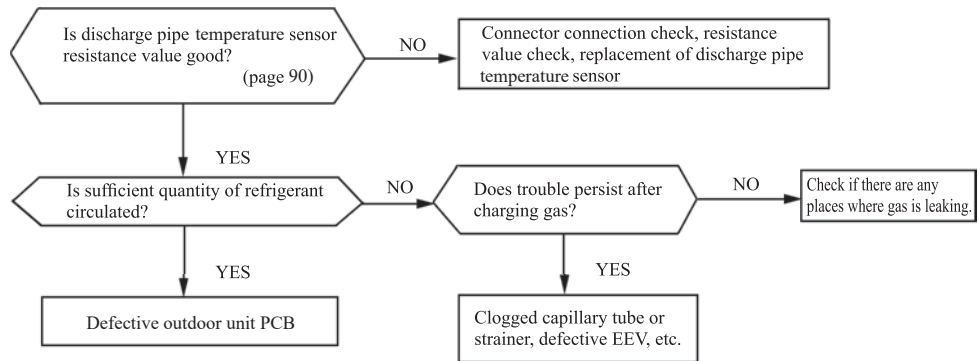

Error of signal transmission

[Wiring error including power cable, defective indoor/outdoor unit PCB]

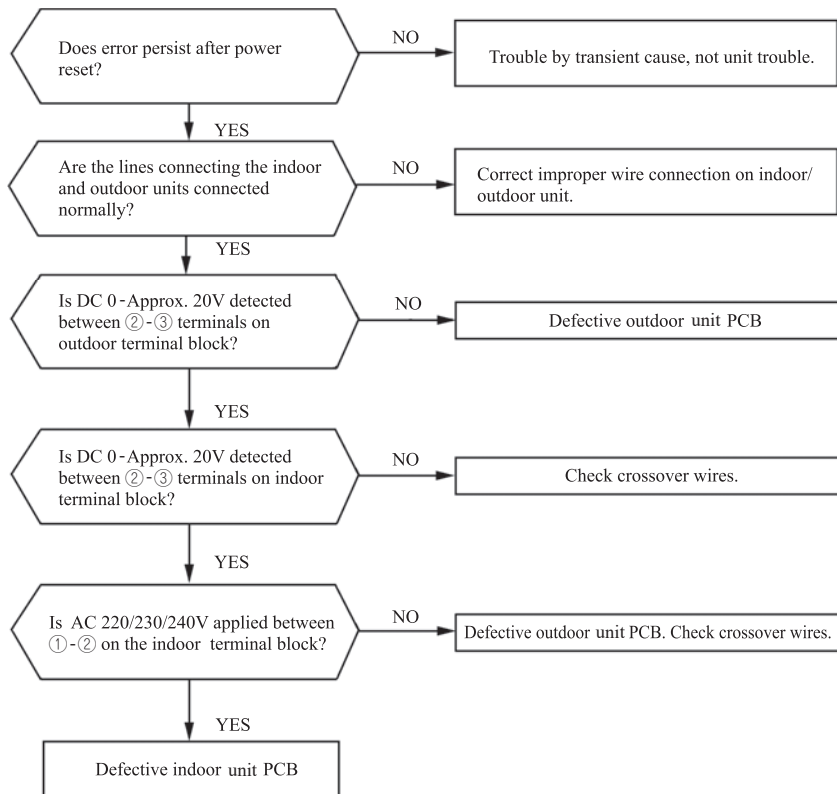

Trouble of outdoor unit

[Insufficient refrigerant amount, Faulty power transistor, Broken compressor wire]
 [Service valve close, Defective EEV, Defective outdoor unit PCB]

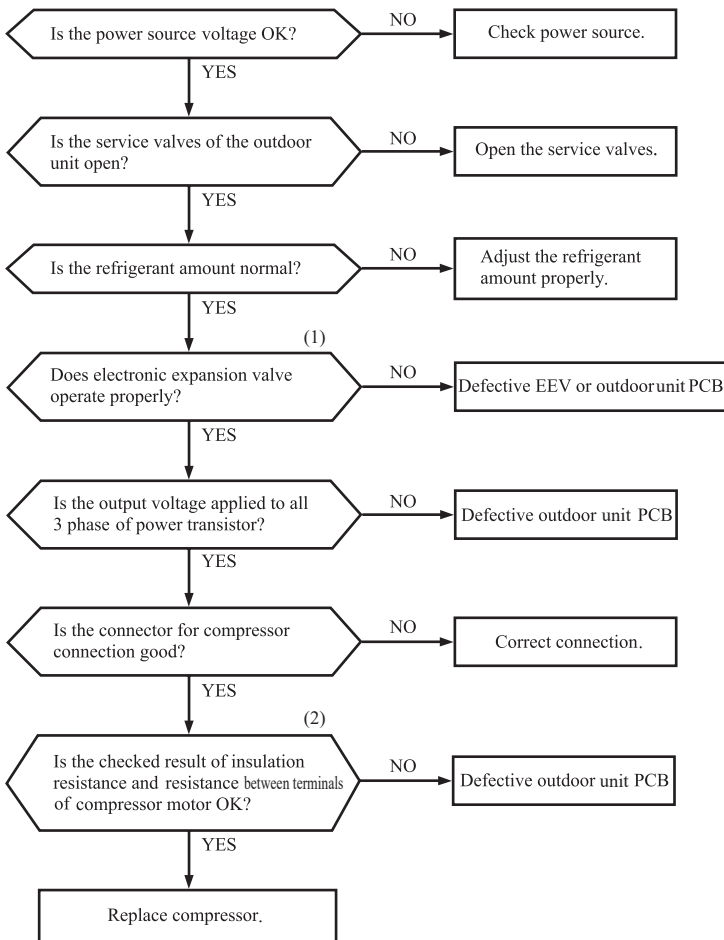

Proper power source voltages are as follows.
 (At the power source outlet)
 AC220V : AC 198-242V
 AC230V : AC 207-253V
 AC240V : AC 216-264V

- ◆ Judgment of refrigerant quantity
- (1) Phenomenon of insufficient refrigerant
 - (a) Loss of capacity
 - (b) Poor defrost operation
(Frost is not removed completely.)
 - (c) Longer time of hot keep
(5 minutes or more)
(Normal time: Approx. 1 – 1 minute and 30 seconds)

Notes (1) For inspection of electronic expansion valve, see page 100.

(2) Check resistance between terminals, see page 91.

Outdoor fan motor error

[Defective fan motor, connector poor connection, defective outdoor unit PCB]

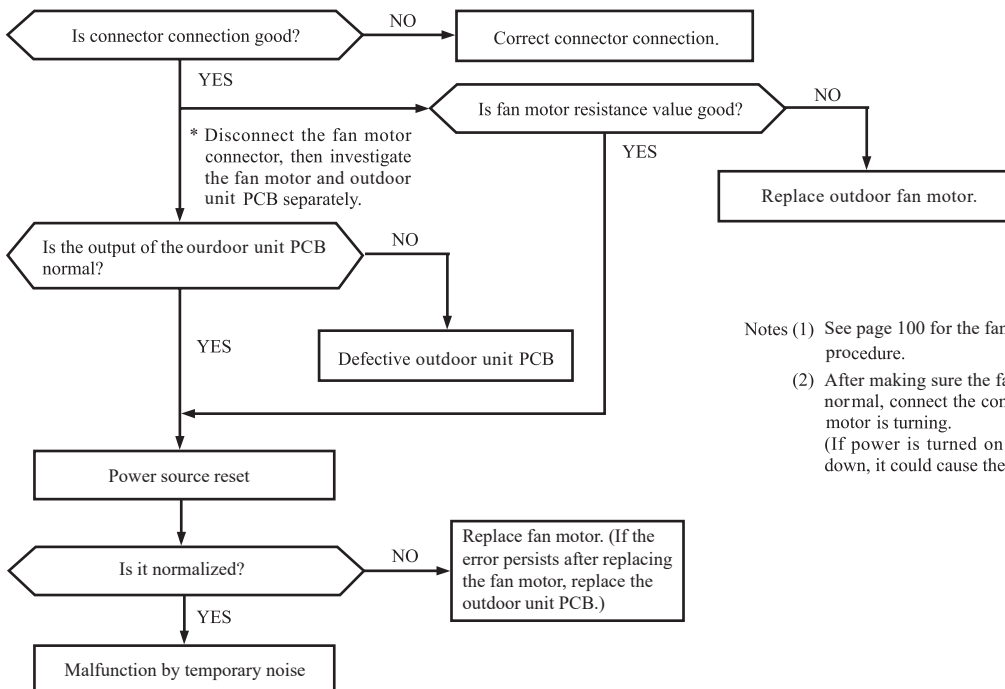

Notes (1) See page 100 for the fan motor and outdoor unit PCB check procedure.

(2) After making sure the fan motor and outdoor unit PCB are normal, connect the connectors and confirm that the fan motor is turning.
 (If power is turned on while one or the other is broken down, it could cause the other to break down also.)

Rotor lock

[Defective compressor, defective outdoor unit PCB]

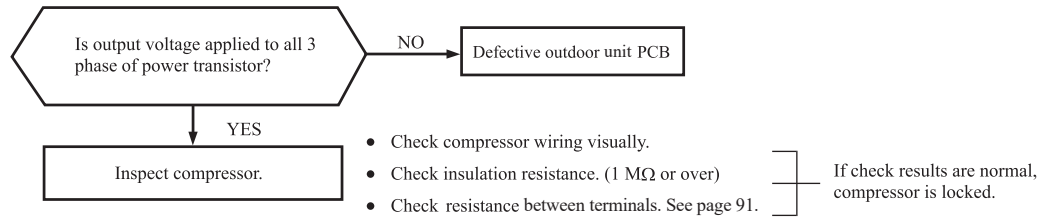

Service valve (gas side) closed operation

[Service valve (gas side) closed, Defective outdoor unit PCB]

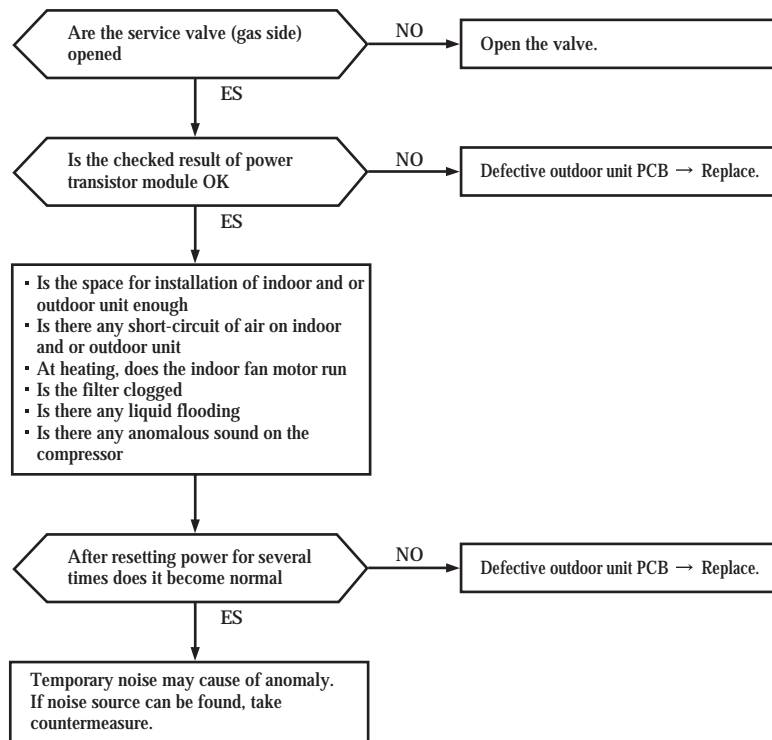

(8) Phenomenon observed after short-circuit, wire breakage on sensor

(a) Indoor unit

Sensor	Operation mode	Phenomenon	
		Short-circuit	Disconnected wire
Room temperature sensor	Cooling	Release of continuous compressor operation command.	Continuous compressor operation command is not released.
	Heating	Continuous compressor operation command is not released.	Release of continuous compressor operation command.
Heat exchanger temperature sensor	Cooling	Freezing cycle system protection trips and stops the compressor.	Continuous compressor operation command is not released. (Anti-frosting)
	Heating	High pressure control mode (Compressor stop command)	Hot keep (Indoor fan stop)
Humidity sensor ⁽¹⁾	Cooling	Refer to the table below.	Refer to the table below.
	Heating	Normal system operation is possible.	

Note (1) SRK35, 50 only.

■ Humidity sensor operation

Failure mode	Control input circuit reading	Air-conditioning system operation
Disconnected wire	① Disconnected wire	Humidity reading is 0%
	② Disconnected wire	
	①② Disconnected wire	
Short-circuit	① and ② are short-circuited	Humidity reading is 100%

Remark: Do not perform a continuity check of the humidity sensor with a tester. If DC current is applied, it could damage the sensor.

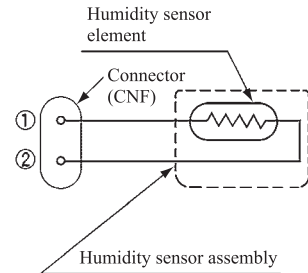

(b) Outdoor unit

Sensor	Operation mode	Phenomenon	
		Short-circuit	Disconnected wire
Heat exchanger temperature sensor	Cooling	Compressor stop.	Compressor stop.
	Heating	Defrost operation is not performed.	Defrost operation is performed for 10 minutes at approx. 35 minutes.
Outdoor air temperature sensor	Cooling	The compressor cannot pick up its speed owing to the current safe so that the designed capacity is not achieved.	Compressor stop.
	Heating	The compressor cannot pick up its speed owing to the heating overload protection so that the designed capacity is not achieved.	Defrost operation is performed for 10 minutes at approx. 35 minutes.
Discharge pipe temperature sensor	All modes	Compressor overload protection is disabled. (Can be operated.)	Compressor stop.

(9) Checking the indoor electrical equipment

(a) Indoor unit PCB check procedure

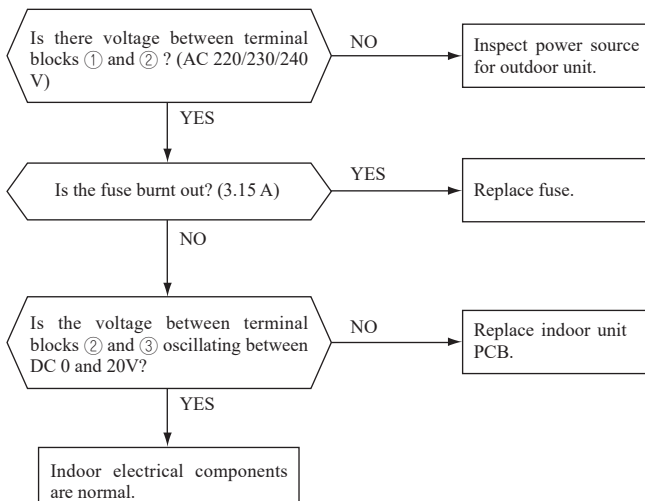

(b) Indoor fan motor check procedure

This is a diagnostic procedure for determining if the indoor fan motor or the indoor unit PCB is broken down.

1) Indoor unit PCB output check

- a) Turn off the power.
- b) Remove the front panel, then disconnect the fan motor lead wire connector.
- c) Turn on the power. If the unit operates when the ON/OFF button is pressed, if trouble is detected after the voltages in the following figure are output for approximately 30 seconds, it means that the indoor unit PCB is normal and the fan motor is broken down.

If the voltages in the following figure are not output at connector pins No. ①, ④ and ⑤, the indoor unit PCB has failed and the fan motor is normal.

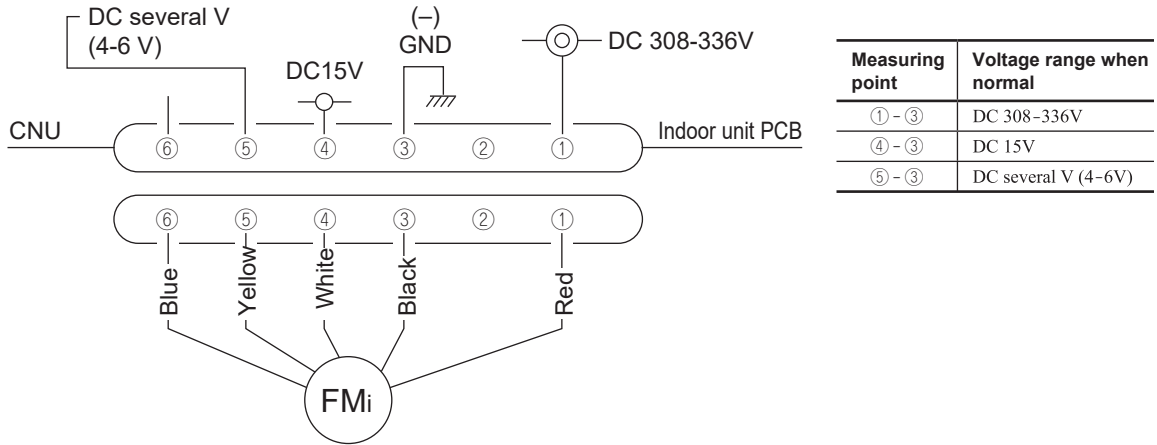

2) Fan motor resistance check

Measuring point	Resistance when normal
① - ③ (Red - Black)	20 MΩ or higher
④ - ③ (White - Black)	20 kΩ or higher

- Notes (1) Remove the fan motor and measure it without power connected to it.
- (2) If the measured value is below the value when the motor is normal, it means that the fan motor is faulty.

(10) How to make sure of wireless remote control

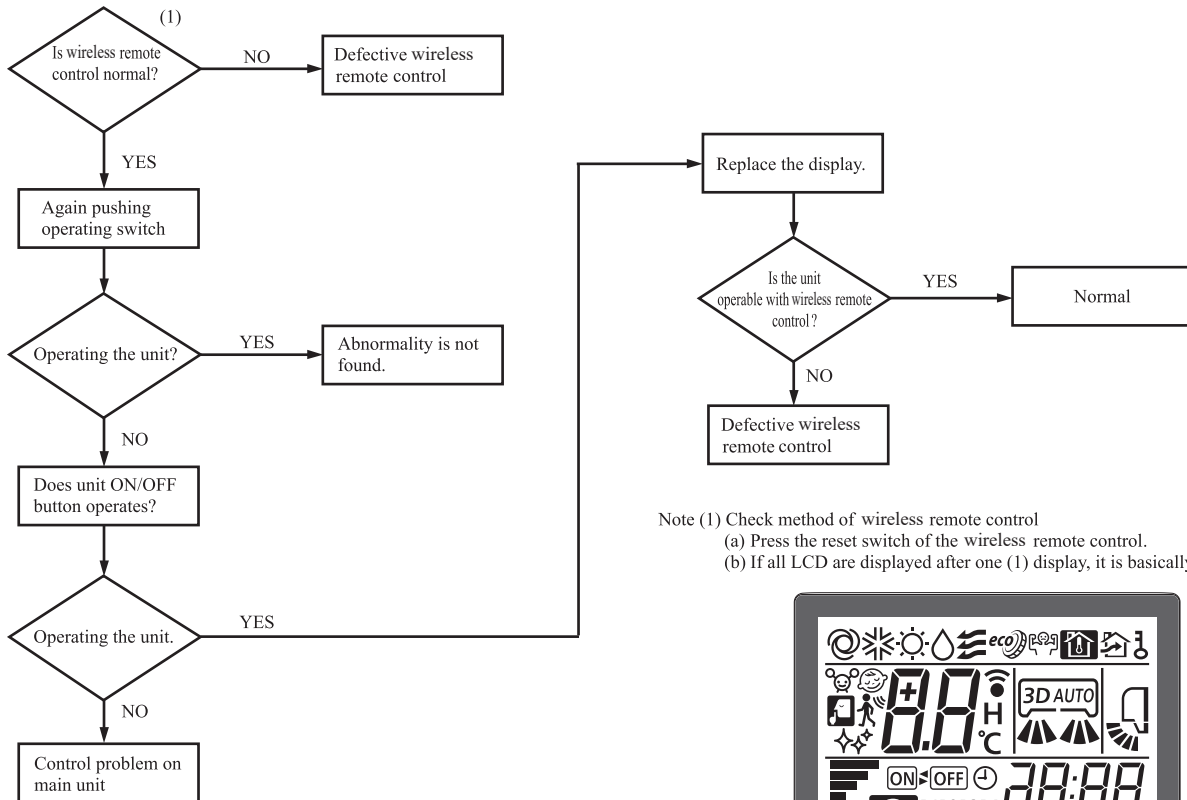

Note (1) Check method of wireless remote control
 (a) Press the reset switch of the wireless remote control.
 (b) If all LCD are displayed after one (1) display, it is basically normal.

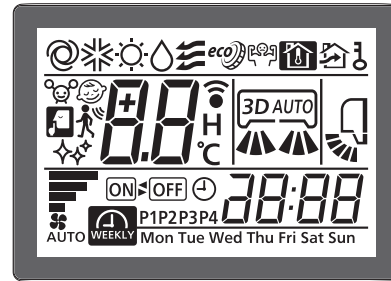

◆ Simplified check method of wireless remote control
 It is normal if the signal transmission section of the wireless remote control emits a whitish light at each transmission on the monitor of digital camera.

(11) Inspection procedure for blown fuse on the indoor and outdoor unit PCB

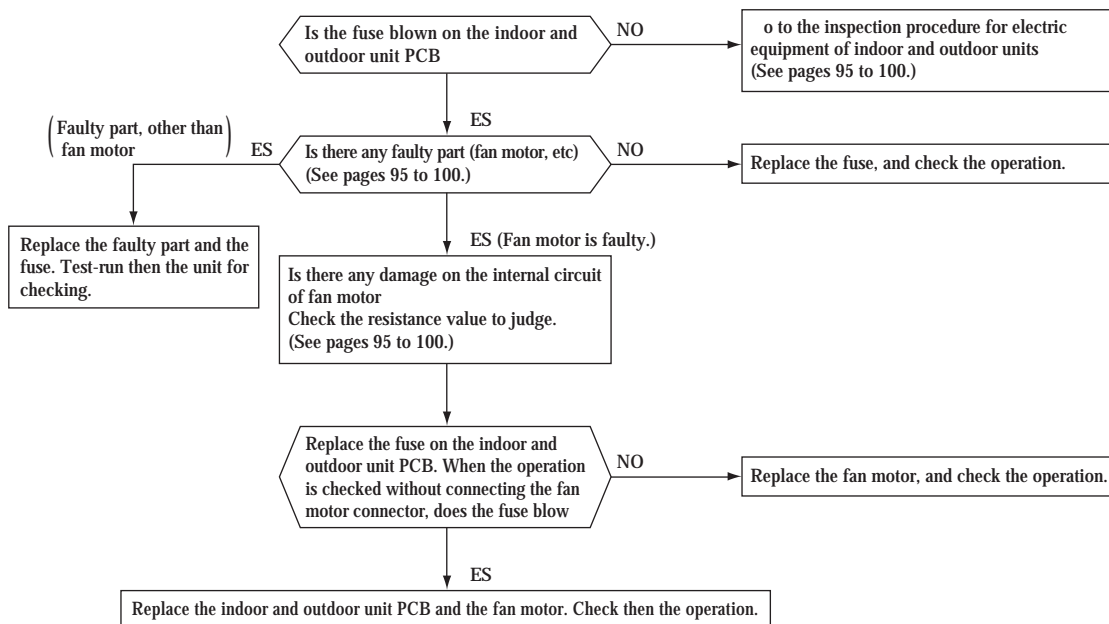

(12) Outdoor unit inspection points

Models SRC20ZS-W, 25ZS-W, 35ZS-W
 SRC25ZS-W1, 35ZS-W1
 SRC25ZS-W2, 35ZS-W2

◆ Inspection point of outdoor unit

⚠
 High voltage is produced in the control box. Don't touch electrical parts in the control box for 5 minutes after the unit is stopped.

◆ Power source and serial signal inspection
 ① to ③ : AC 220 230 240
 ① to ②(N) : AC 220 230 240
 ②(N) to ③ : Normal if the voltage oscillates between DC 0 and approx. 20

Mark	Color
BK	Black
BL	Blue
BR	Brown
OR	Orange
RD	Red
WH	White
E	Yellow
/	Yellow / Green

◆ Voltage inspection
 The normal range is as follows.

Display	Voltage range
① DC280	DC230 - DC310
② DC 20	DC 18 - DC 22
③ DC 13	DC 12 - DC 14
④ DC 15	DC 14 - DC 16
⑤ DC 5	DC 4 - DC 6
⑥ DC 2.5	DC 2.3 - DC 2.5

Power source
 1 Phase
 AC200-240 50Hz

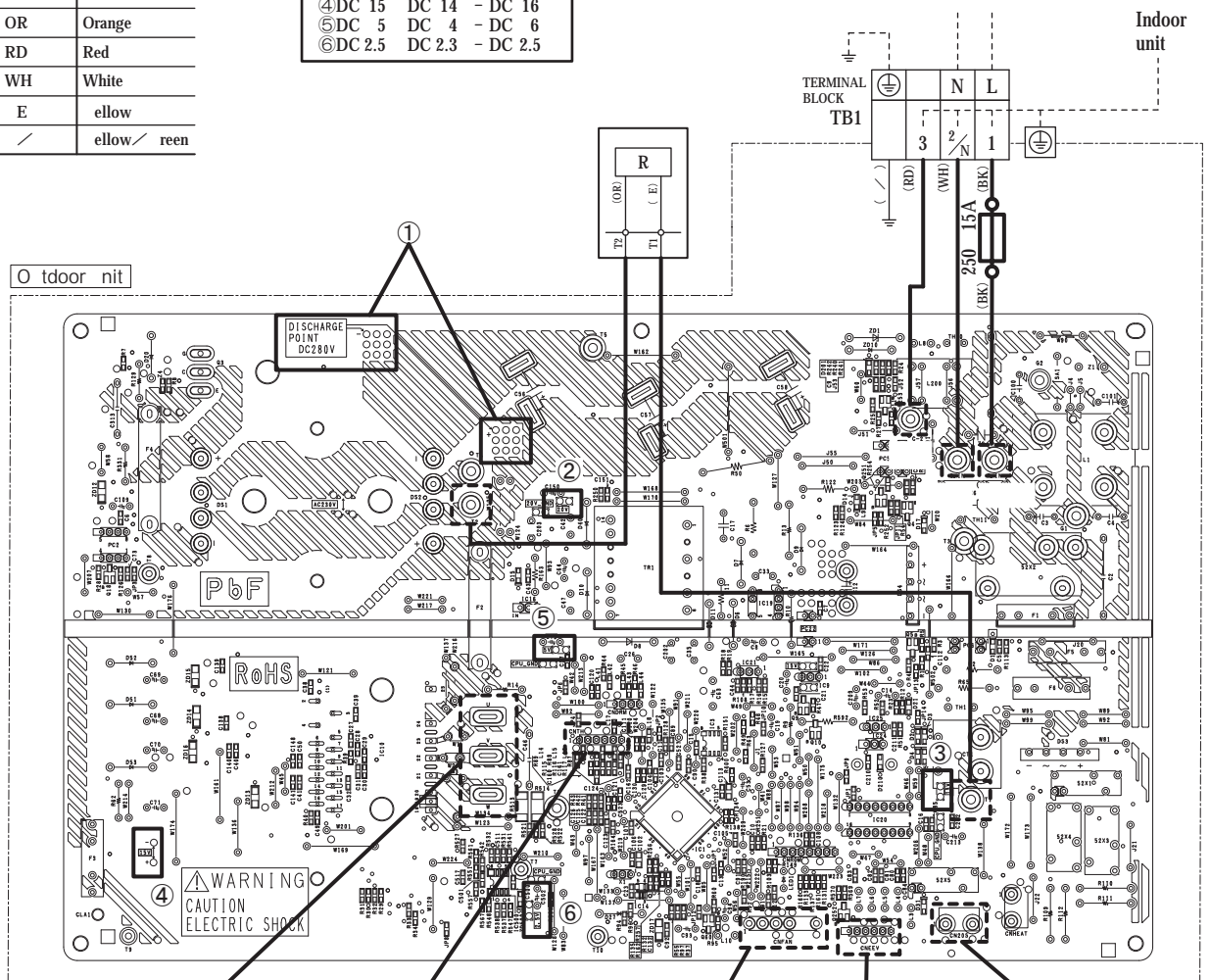

◆ Inspection point of compressor motor
 Remove the faston terminal and test output voltage

◆ Inspection point of resistance value of sensor
 Remove the connector and check the resistance value.
 See the section of sensor characteristics on page 90.

◆ Inspection point of outdoor fan motor
 See page 100.

◆ Inspection point of electronic expansion valve
 See page 100.

odel

◆ ec point o o tdoor nit

⚠ High voltage is produced in the control box. Don't touch electrical parts in the control box for 5 minutes after the unit is stopped.

olor sy ol

Mark	Color
BK	Black
BL	Blue
RD	Red
WH	White
E	ellow
/	ellow / reen

◆ olta ec ec in
The normal range is as follows.

Display	oltage range
① DC 280	DC 230 -DC 310
② DC 20	DC 18 -DC 22
③ DC 13	DC 12 -DC 14
④ DC 15	DC 14 -DC 16
⑤ DC 5	DC 4 -DC 6
⑥ DC 2.5	DC 2.3 -DC 2.5

◆ nspection po er transistor
Remove the faston terminal and test output voltage

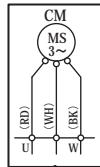

◆ o er so rce and serial si nal inspection
① to ② : AC 220 230 240
① to ② N : AC 220 230 240
② N to ③ : Normal if the voltage oscillates between DC 0 and approx. 20

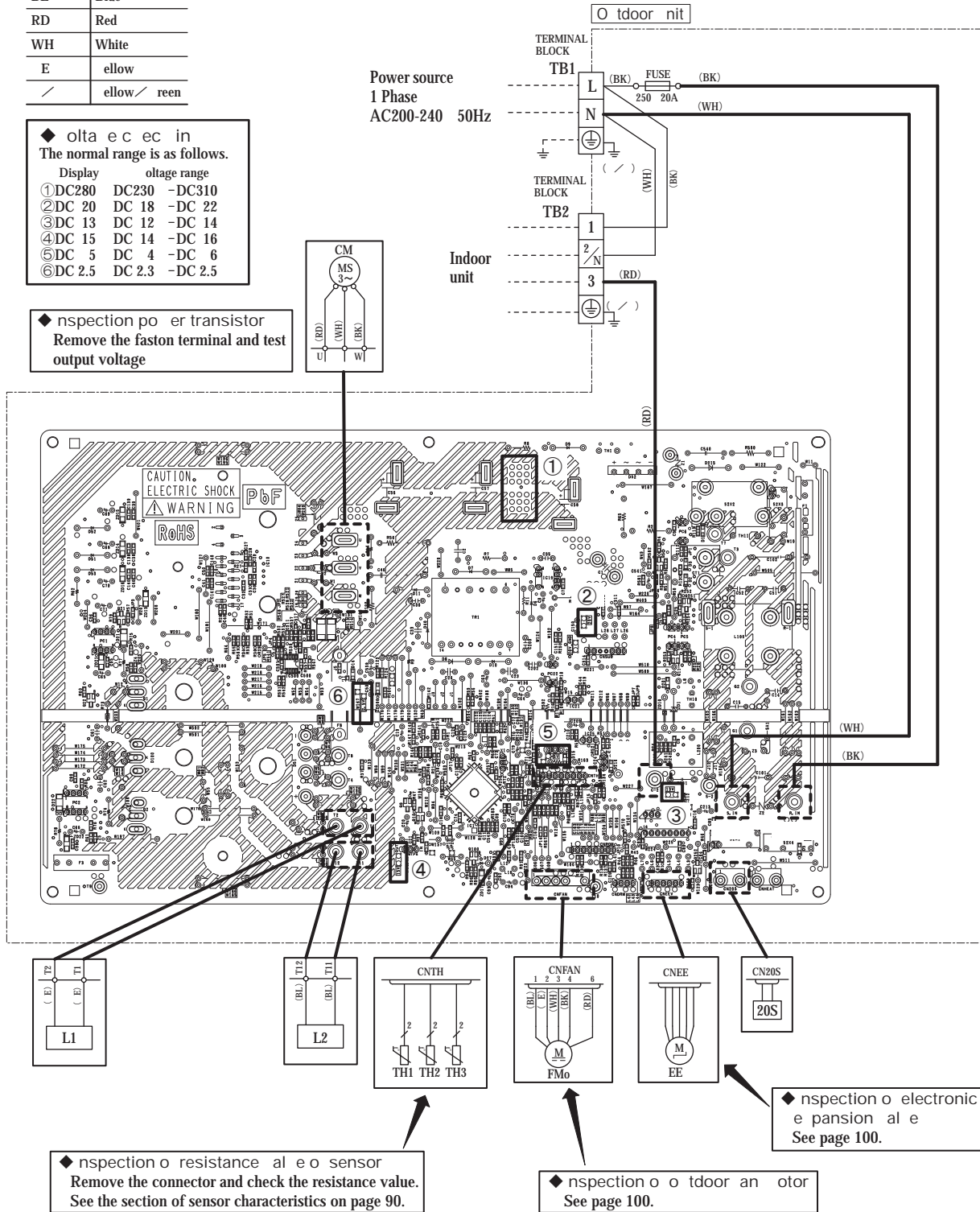

◆ nspection o resistance al eo sensor
Remove the connector and check the resistance value.
See the section of sensor characteristics on page 90.

◆ nspection o o tdoor an otor
See page 100.

◆ nspection o electronic expansion al e
See page 100.

(a) Inspection of electronic expansion valve

Electronic expansion valve operates for approx. 10 seconds after the power on, in order to determine its aperture. Check the operating sound and voltage during the period of time. (Voltage cannot be checked during operation in which only the aperture change occurs.)

- (i) If it is heard the sound of operating electronic expansion valve, it is almost normal.
- (ii) If the operating sound is not heard, check the output voltage.

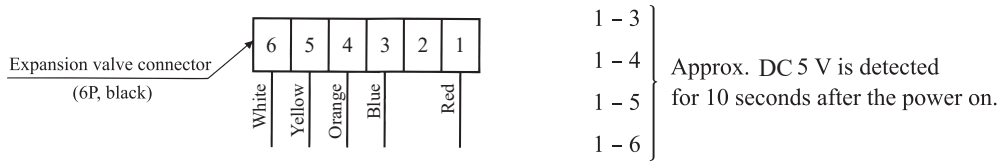

- (iii) If voltage is detected, the outdoor unit PCB is normal.
- (iv) If the expansion valve does not operate (no operating sound) while voltage is detected, the expansion valve is defective.

• Inspection of electronic expansion valve as a separate unit

Measure the resistance between terminals with an analog tester.

Measuring point	Resistance when normal
1-6	46 ± 4Ω (at 20°C)
1-5	
1-4	
1-3	

(b) Outdoor fan motor check procedure

- When the outdoor unit fan motor error is detected, diagnose which of the outdoor unit fan motor or outdoor unit PCB is defective.
- Diagnose this only after confirming that the indoor unit is normal.

(i) Outdoor unit PCB output check

- 1) Turn off the power.
- 2) Disconnect the outdoor fan motor connector CNFAN.
- 3) When the indoor unit is operated by inserting the power source plug and pressing (ON) the backup switch for more than 5 seconds, if the voltage of pin No. ② in the following figure is output for 30 seconds at 20 seconds after turning “ON” the backup switch, the outdoor unit PCB is normal but the fan motor is defective.

If the voltage is not detected, the outdoor unit PCB is defective but the fan motor is normal.

Note (1) The voltage is output 3 times repeatedly. If it is not detected, the indoor unit displays the error message.

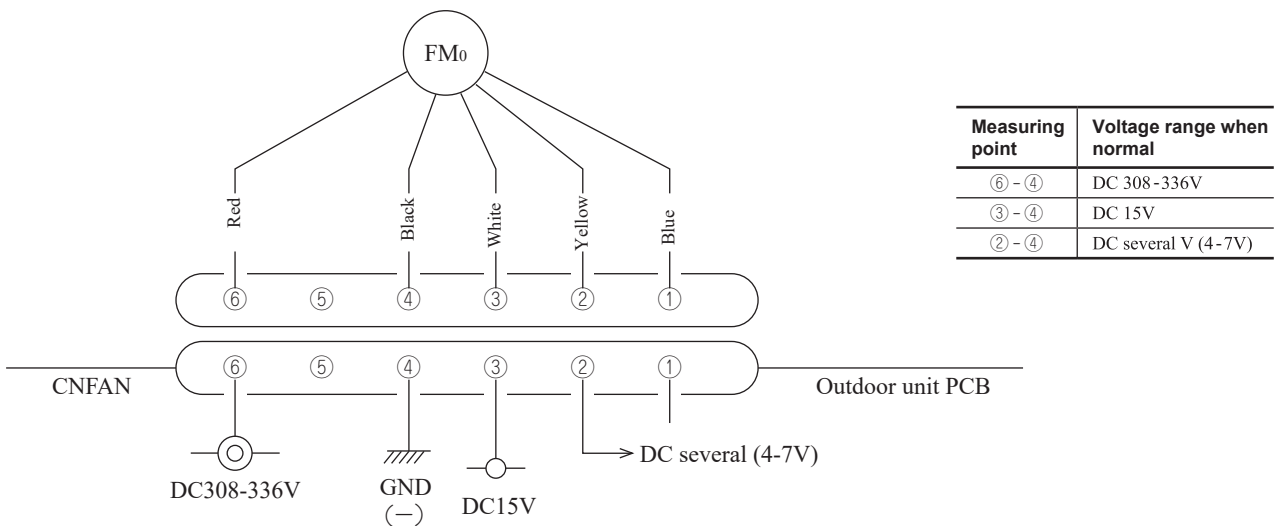

(ii) Fan motor resistance check

Measuring point	Resistance when normal
⑥ - ④ (Red - Black)	20 MΩ or higher
③ - ④ (White - Black)	20 kΩ or higher

- Notes (1) Remove the fan motor and measure it without power connected to it.
- (2) If the measured value is below the value when the motor is normal, it means that the fan motor is faulty.

11. INDOOR UNIT DISASSEMBLY METHOD

(1) Remove the cover.



(2) Remove the screw(The following 2 places).

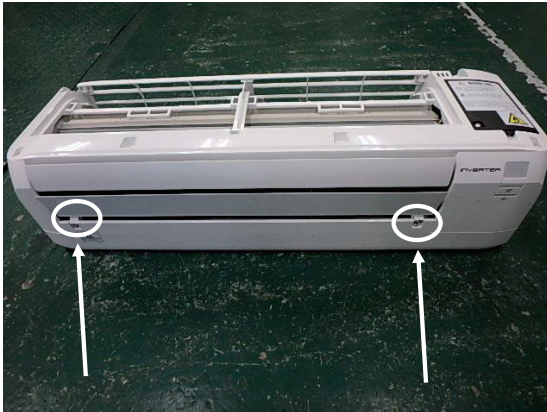

(3) Remove the end cover.



(4) Remove nails (4 places).

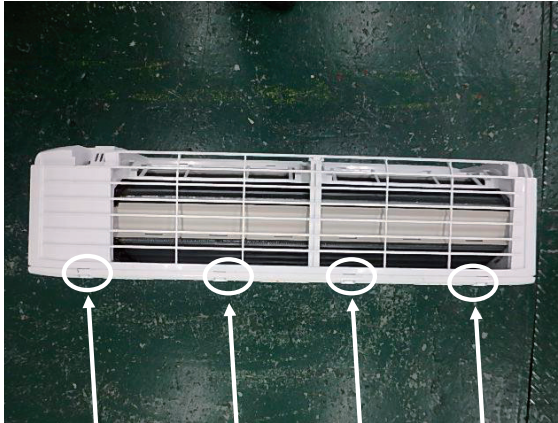

(5) Remove the cover.

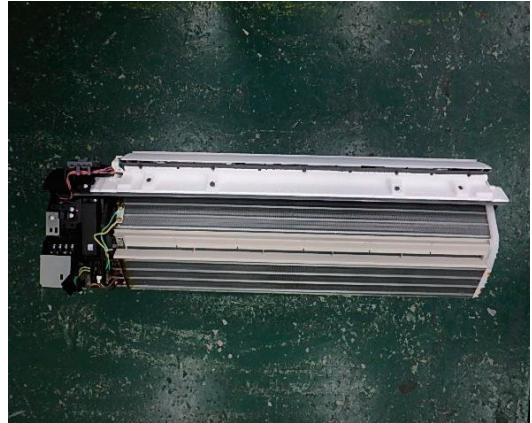

(6) Remove the control cover.

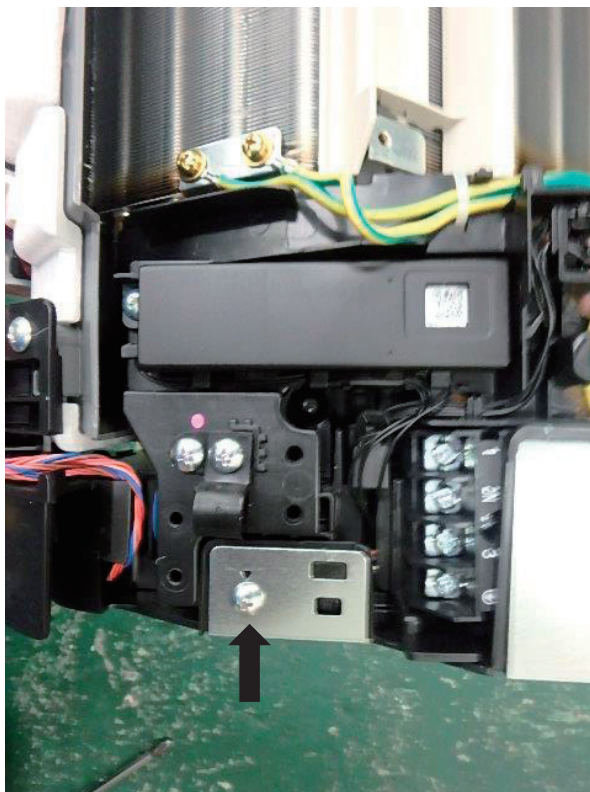

(7) Unplug the connector.

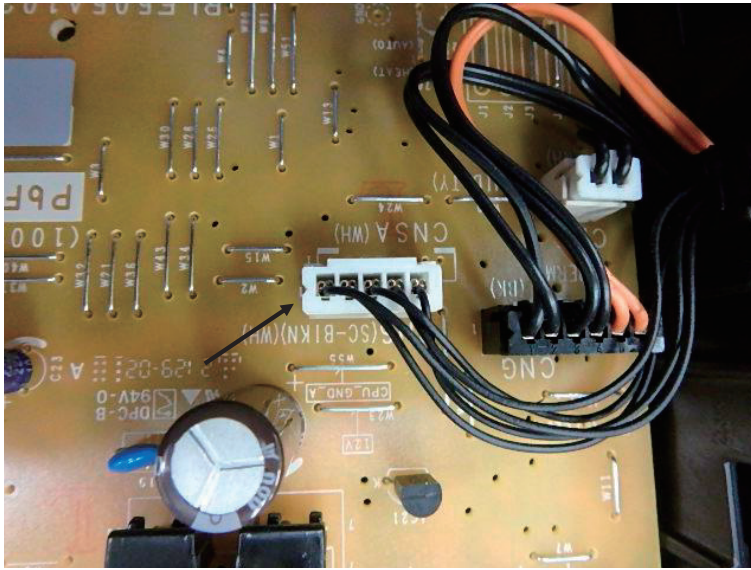

(8) Unscrew.

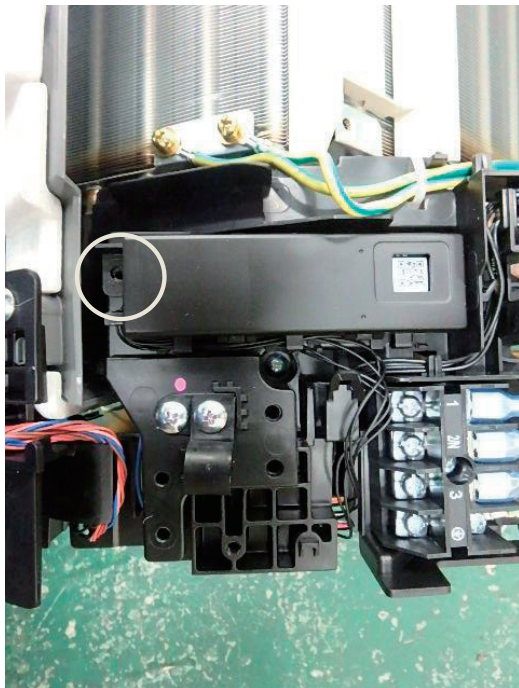

(9) Pull out control.

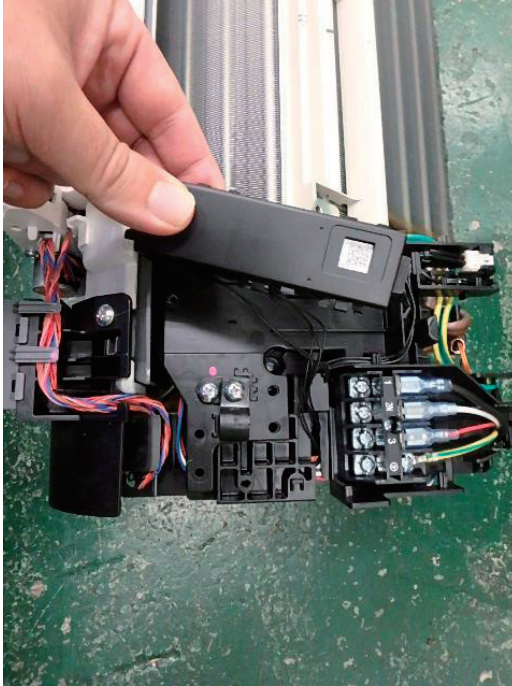

SRK20-50ZS-WF Operation table

Function	Setting	Operation by remote control	Operation by Smart M-Air	Operation by wired remote control (SC-BIKN2) *1
ON/OFF	ON	○	○	○
	OFF	○	○	○
OPERATION MODE select	AUTO	○	○	○
	COOL	○	○	○
	HEAT	○	○	○
	DRY	○	○	○
	FAN	○	○	○
	SELF CLEAN	○	×	×(Displayed as OFF)
	ALLERGEN CLEAR	○	×(Displayed as FAN)	×(Displayed as FAN)
	NIGHT SETBACK	○	×(Displayed as HEAT)	×(Displayed as HEAT)
	Home leave mode	–	○	○
	Vacant property mode	–	○	–
Temperature adjustment	18°C—30°C	○	○	○
FAN SPEED	AUTO	○	○	○
	HIGH POWER	○	×(Displayed as ■■■■)	×(Displayed as Hi)
	Hi	○	○ (Displayed as ■■■■)	○ (Displayed as PHi)
	Me	○	○ (Displayed as ■■■)	○ (Displayed as Hi)
	Lo	○	○ (Displayed as ■■)	○ (Displayed as Me)
	ULo	○	○ (Displayed as ■)	○ (Displayed as Lo)
	ECONO	○	×(Displayed as ■)	×(Displayed as Lo)
Air flow direction adjustment	Up/down (1 step)	○	○	○
	Up/down (2 step)	○	○	○
	Up/down (3 step)	○	×(Displayed as 2 step)	×(Displayed as 2 step)
	Up/down (4 step)	○	○ (Displayed as 3 step)	○ (Displayed as 3 step)
	Up/down (5 step)	○	○ (Displayed as 4 step)	○ (Displayed as 4 step)
	Up/down (swing)	○	○	○
	Up/down (flap stopped)	○	×(Displayed as 2 step)	×(Displayed as 2 step)
	Left/right (leftmost)	○	○	○
	Left/right (left)	○	○	○
	Left/right (middle)	○	○	○
	Left/right (right)	○	○	○
	Left/right (rightmost)	○	○	○
	Left/right (wide)	○	○	○
	Left/right (spot)	○	○	○
	Left/right (swing)	○	○	○
	Left/right (louver stopped)	○	×(Displayed as middle)	×(Displayed as middle)
	3D AUTO	○	○	○
TIMER function	Various TIMERS	○	–	○
	WEEKLY TIMER	○	○	○
MENU function	Display brightness adjustment	○	–	–
	Fan control in heating thermo-OFF	○	–	○
	SELF CLEAN setting	○	–	–
	Silent setting	–	–	–
	Wireless LAN connection setting	○	–	–
Wireless LAN communication	○	–	–	
Other function	Installation location setting	○	–	–
	Silent	○	–	○
	Initialization of wireless LAN	○	–	–
	Electricity bill display	–	○	○
	Shut-off reminder alert	–	○	–

○ : Operation/Setting Available

× : Operation/Setting/Display N/A

– : No function

*1 : Option part