

Centralized Controller CE52-24/F(C)

Model: CE52-24/F(C)

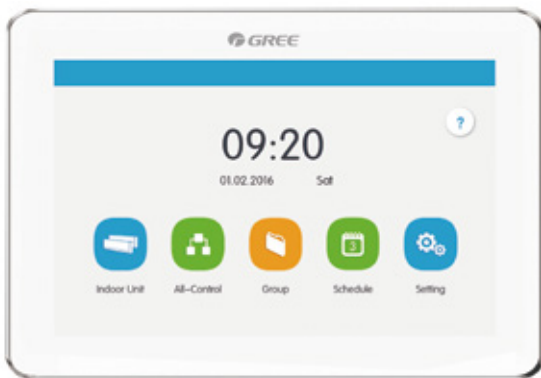





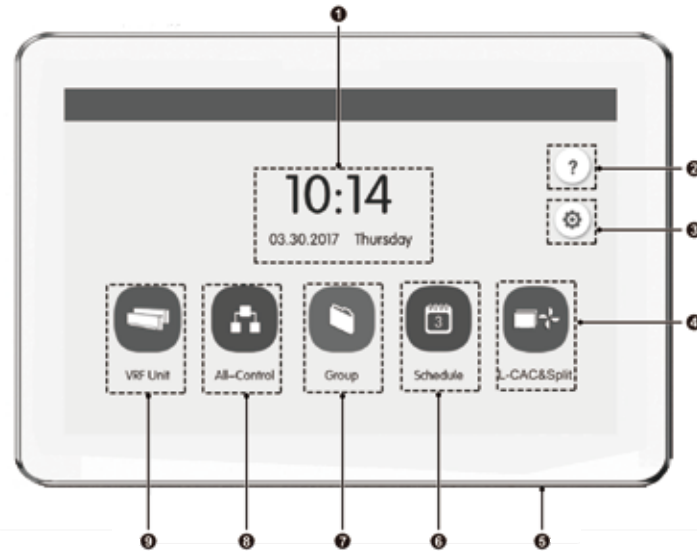

- With various functions: centralized control (control all indoor units), group management (support DIY grouping), schedule management (setting of several schedules, support special schedule setting such as holiday) and single indoor unit control (on/off, mode, temp setting, fan speed, quiet, swing control, etc.)

- Elegant and fashionable appearance;
- Color LCD, fine display and true color;
- 7-inch capacitive touch screen for easy operation;
- Up to 255 units can be centrally controlled;
- Connectable with network of indoor units or outdoor units;
- Independent power supply in 100~240V wide voltage range;
- Embedded installation in wall with projecting thickness only of 11mm;
- With project setting, parameter viewing, malfunction record and access management functions;
- Shielding function of single unit, group and all IDUs (shielding on/off, mode, temp setting, etc.), long-distance control at will;
- Provide naming of indoor units, selection of icons and personalized settings of centralized controller (setting background, back-light, etc.);

Job Name:		Date:	
System Reference No.:			
Engineer Signature:			



No.	Name	Instructions
1	Time zone	The present date, week and time.
2	Help button 	Press this button to enter Help Info page.
3	Setting button 	Press this button to enter setting page.
4	L-CAC&Split unit button 	Press this button to enter L-CAC&Split unit page.
5	Touch button	<ul style="list-style-type: none"> ● Press the Touch Button to turn on/off the screen of centralized controller. ● Press and hold the Touch Button for 5sec to restart to centralized controller.
6	Schedule button 	Press this button to enter schedule page.
7	Group button 	Press this button to enter group page.
8	All-Control button 	Press this button to enter All-Control page.
9	VRF Unit button 	Press this button to enter indoor units, water/floor units or fresh air units control page.

Outline and Physical Dimensions of CE52-24/F(C) .

Unit:mm(in)

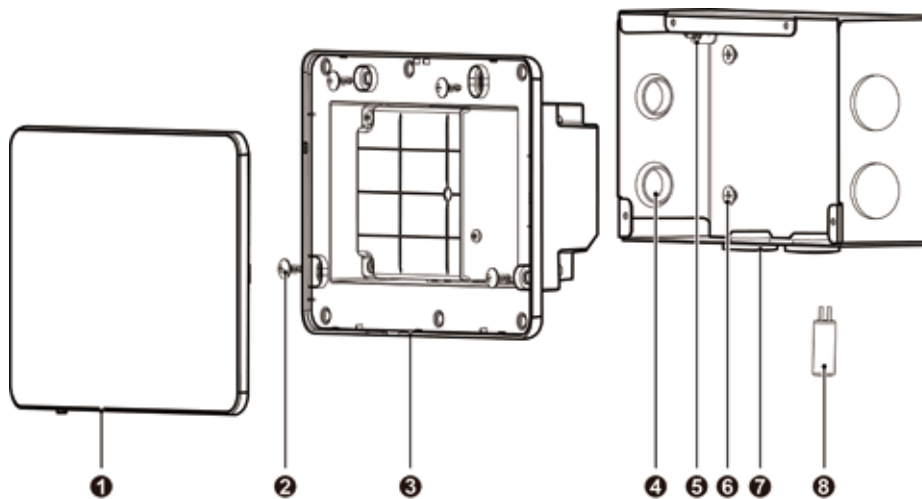
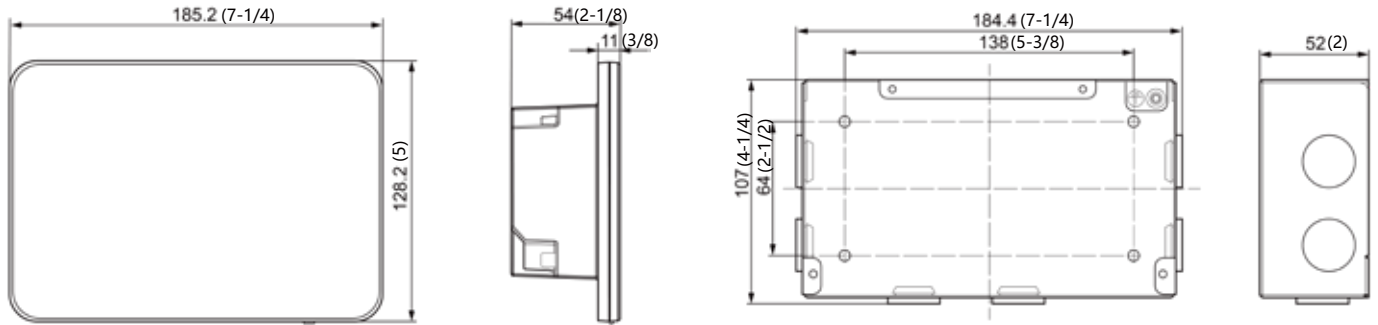

No.	①	②	③	④
Name	Touch screen	Self-tapping screw ST4.2×9.5 MC(used to secure the rear cover of controller)	Rear cover of controller	Rubber band
QTY	1	4	1	6
No.	⑤	⑥	⑦	⑧
Name	Screw M4×12 (used to secure earthing wire)	Screw ST4.2×16 FA (used to secure electric box cover)	Electric box cover	Matching resistance
QTY	1	4	1	2